



Installation Instructions

BR5 Front Bumper Replacement Part Number 24178T

2014-2016 Toyota Tundra 2/4WD (Excludes Platinum Models)

Do not attempt to install this product on any vehicle other than the one listed above!

Parts List

Item	Qty.	Part #	Description
1	1		Bumper Replacement Shell
2	1		Mounting Plate/Winch Tray
3	1		Driver Frame Bracket
4	1		Passenger Frame Bracket
5	1		Driver Auxiliary Bracket
6	1		Passenger Auxiliary Bracket
7	1		Driver Extension Bracket
8	1		Passenger Extension Bracket
9	1		Driver Support bracket
10	1		Passenger Support Bracket
11	1		Driver Side Vent Cover
12	1		Passenger Side Vent Cover
13	1		Winch Cover
14	2		Light Pod Plate
15	1		Driver Sensor Plate
16	1		Passenger Sensor Plate

Item	Qty.	Part #	Description	Torque
18	1		License Plate Bracket	
19	2		Vinyl Gasket	
20	2		Hole Plug (large)	
21	4		Hole Plug (small)	
22	8		1/2" x 1 1/2" Hex Bolt	64 ft. lbs.
23	16		1/2" x 1 1/2" Carriage Bolt	64 ft. lbs.
24	28		1/2" Flat Washer	
25	26		1/2" Lock Washer	
26	20		1/2" Hex Nut	
27	2		1/2" T-Bolt	
28	2		3/8" x 1 1/4" Hex Bolt	26 ft. lbs.
29	2		3/8" Lock Washer	
30	2		3/8" Flat Washer	
31	2		3/8" Hex Nut	
32	38		1/4" x 3/4" Button Head Bolt	71 in. lbs.
33	10		1/4" Nylon Lock Nut	

ILLUSTRATION #1

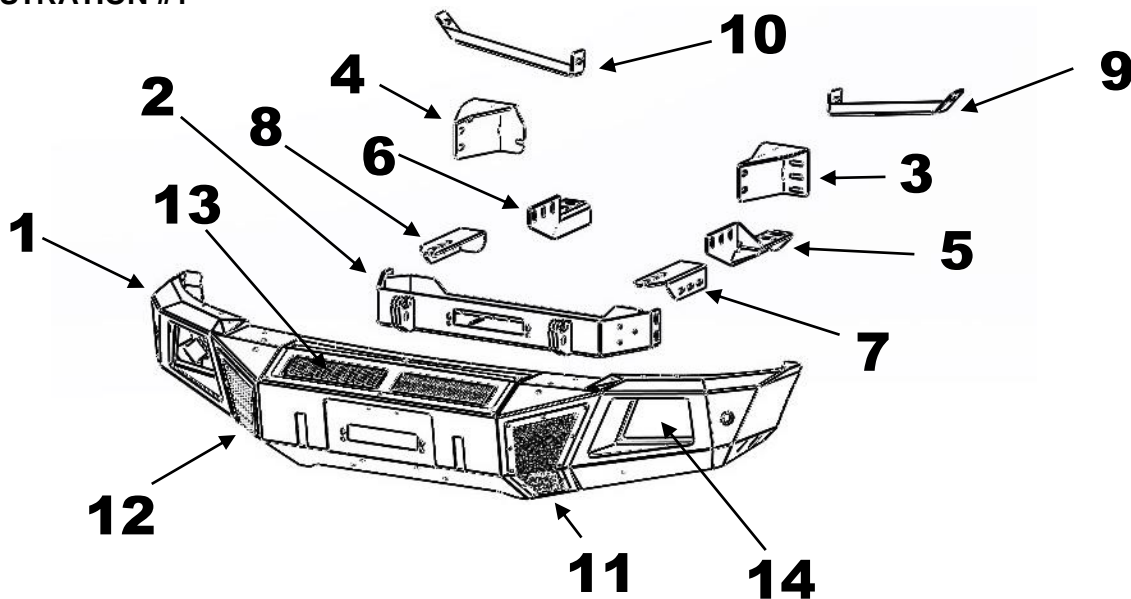

Tool Required:

10mm, 12mm, 14mm, 7/16", 9/16" & 3/4" Sockets & Wrenches
Slotted Blade Screw Driver
5/32" Hex Key
Ratchet, Ratchet Extensions & Swivel Joint Adapter

Approximate installation time: 90 min.

IMPORTANT INSTALLATION NOTES AND SUGGESTIONS

The pre-installed Mesh Winch and Vent Covers need to be removed using hand tools to slowly remove the bolts. Using an air assisted impact or ratchet will damage the bolt threads and the internal nut assembly in the bumper shell. Use of an appropriate anti-seize compound is highly recommended for re-installation, and tighten the bolts to the specified torque as overtightening could result in difficulty of future removal.

If you are replacing a bumper with front Park Assist, the sensor detection zone will be altered with use of this bumper replacement.

To maintain and care this product keep it clean and do not use abrasive cleaners or polish waxes.

Texture

Painted Finish: Mild liquid detergent may be used. **Polished Stainless & Semi-Gloss Painted Finishes:** We recommend using only non-abrasive automotive wax such as pure carnauba to avoid scratches and rust.

Read the installation instructions completely and verify that all of the parts listed are accounted for. If you have defective, missing or damaged parts or need assistance, please contact Go Rhino Products for fast, friendly customer service at: (888) 427-4466 or email: sales@gorhino.com

Front Bumper Removal

Step-1 Disconnect the vehicle battery.

Step-2 Beginning on the driver side, remove (1) tree clip securing the front section of the fender liner to the side of the frame, (Photo 1).

Step-3 Remove the (2) screws from the inside and the (2) screws and (2) bolts from the bottom securing the front section of the fender liner to the bumper, (Photo 2 & 3).

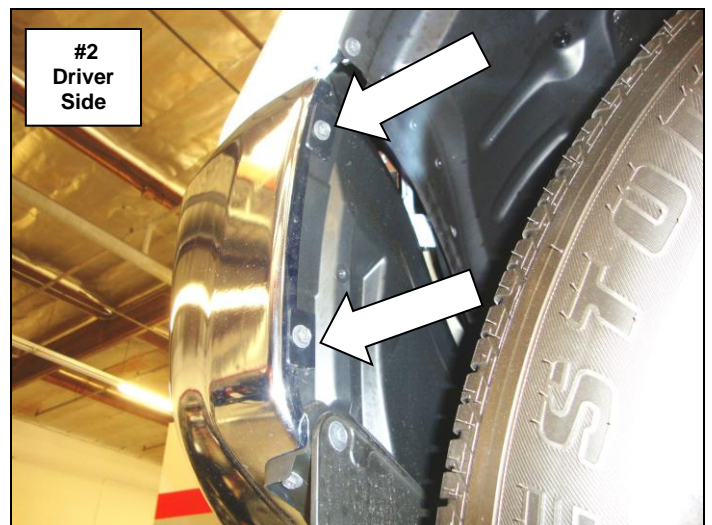
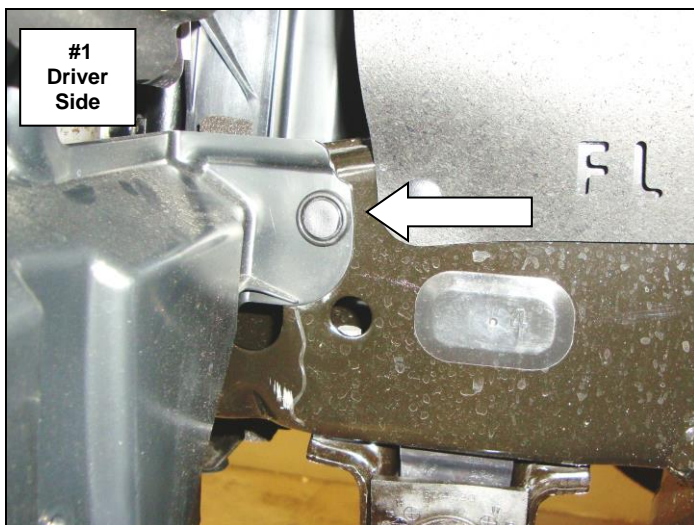

Step-4 Remove the front sections fender liner from the bumper and if equipped disconnect the factory fog light wiring harness from the fog light, (Photo 4).

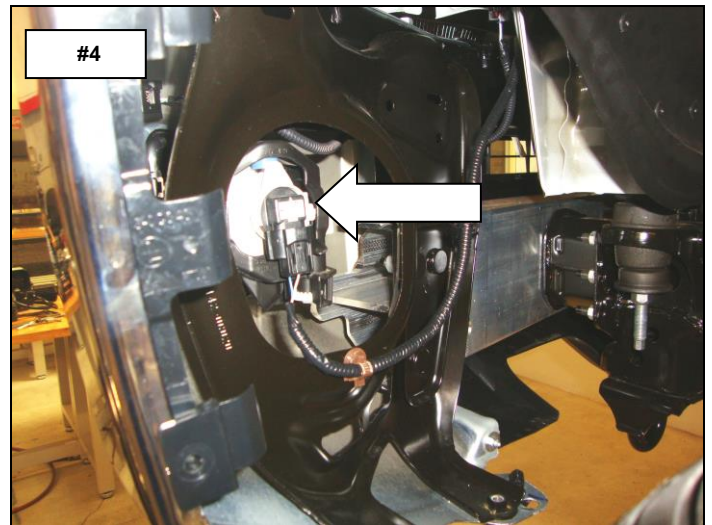
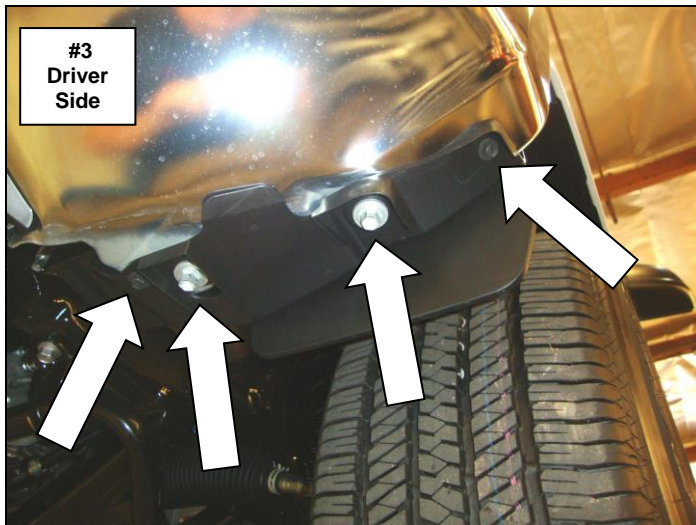

Step-5 Remove the (4) nuts securing the bumper connector bracket to the end of the frame rail, (Photo 5). Retain the nuts as they will be used to secure the mounting plate/winch tray brackets to the vehicle.

Repeat steps 2 - 5 for the passenger side.

Step-6 Remove the (3) screws securing the bottom of the plastic bumper valance, (Photo 6).

Step-7 If equipped with front park assist, disconnect the sensor wiring pig tail from the vehicle wiring harness. With assistance remove the bumper from the vehicle by pulling forward away from the vehicle and rolling forward.

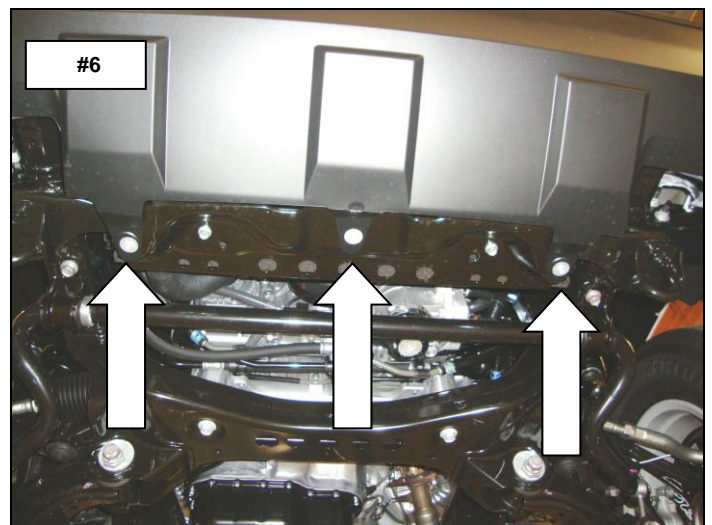
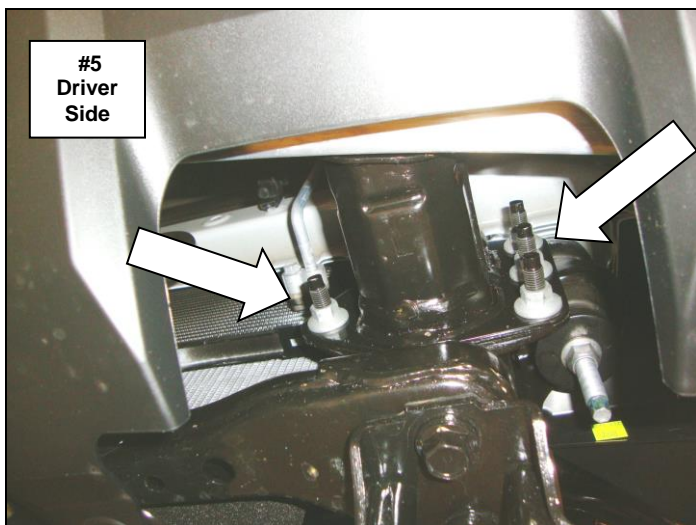

Bumper Replacement Installation

Notes: if your vehicle is not equipped with front parking assist sonar install the supplied round plugs in the holes in the bumper replacement and proceed to Step 6.

Step-1 If the vehicle is equipped with front parking assist sonar, remove the retaining clip securing the sensor to the factory bumper, push the sensor out through the hole in the factory bumper then lift the tab on the plug connector to release the sensor, (Photo 1 & 2). Note: Do not push on the front of the sensor as this may damage the sensor.

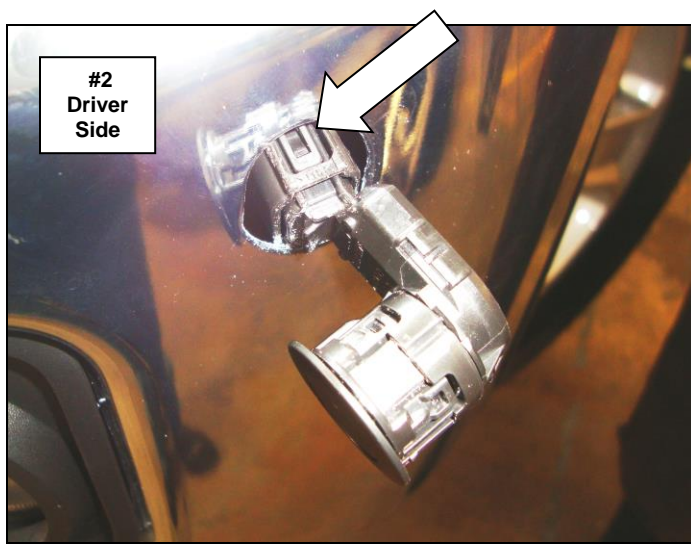
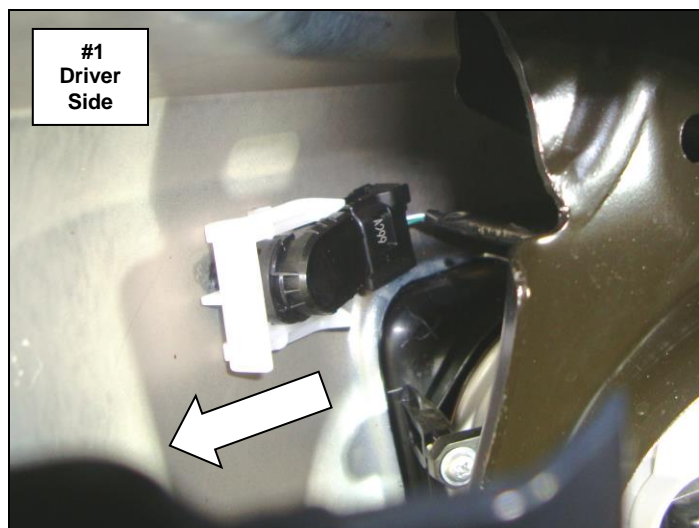

Note: The sensors have to be positioned in the bumper replacement in the same location (driver and passenger) as removed from the factory bumper.

Step-2 Install the sensors in the sensor plates using the factory retaining clips, (Photo 3 & 4). Note: The 4 notches in the sensor plate designate the top, and the single notch on the side position toward the center of the vehicle.

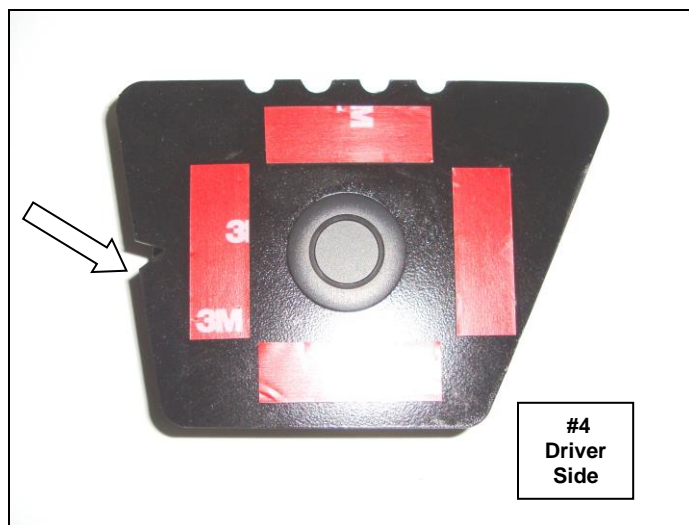
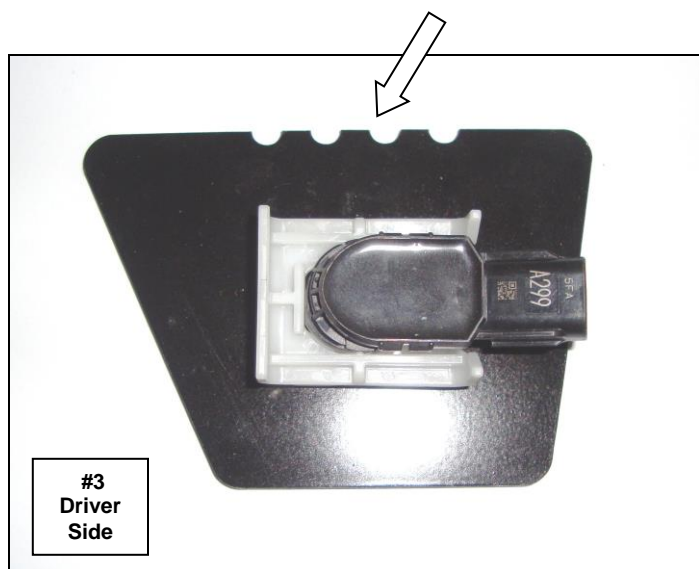

Step-3 Prepare the inside surface of the bumper shell where the bezel plates will be mounted with Isopropyl alcohol. A clean, dry surface is required in order for tape to stick properly.

Step-4 Peel the backing off from the double sided tape to uncover the adhesive. From inside the bumper shell position each bezel, sensor and bezel plate assembly, making sure the sensor bezel is centered in the hole provided in the bumper shell, (Photo 5 & 6).

Step-5 Stick the assembly in place and apply firm pressure for about 30 seconds. The tape needs to bond with the mounting surface, and it needs pressure to do this. The bezel mounting plate will seem like it is stuck on, but continue pressing for at least 30 seconds. Note: At room temperature approximately 50% of ultimate bond strength will be achieved after 20 minutes, 90% after 24 hours and 100% after 72 hours.

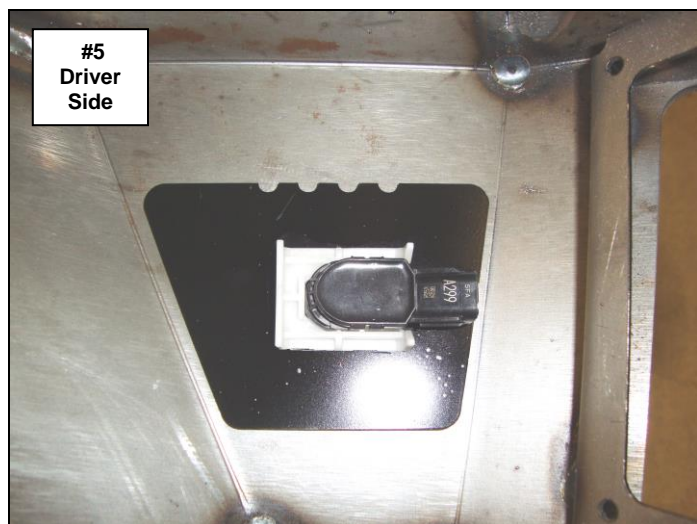

Step-6 Remove (2) bolts and tow hook from the bottom of the frame, (Photo 7). Note: The tow hook will not be reinstalled.

Step-7 Position the driver side auxiliary bracket on the bottom of the frame, align the holes in the bracket with the tow hook attachment holes and secure the auxiliary bracket to the frame using the factory tow hook bolts, (Photo 8). Snug but do not fully tighten the bolts.

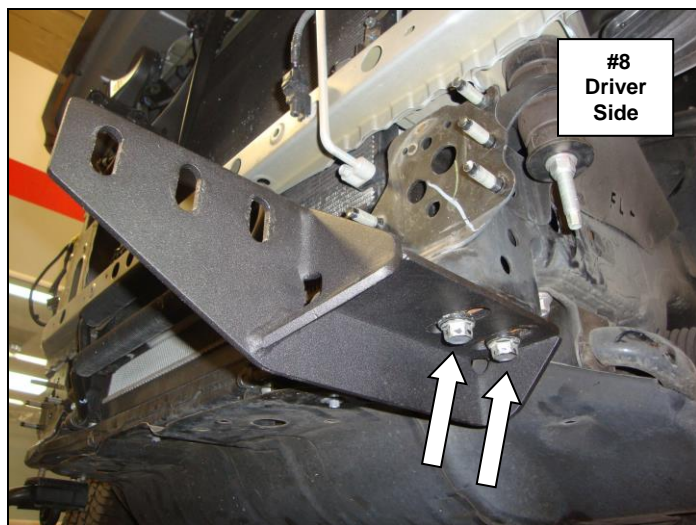
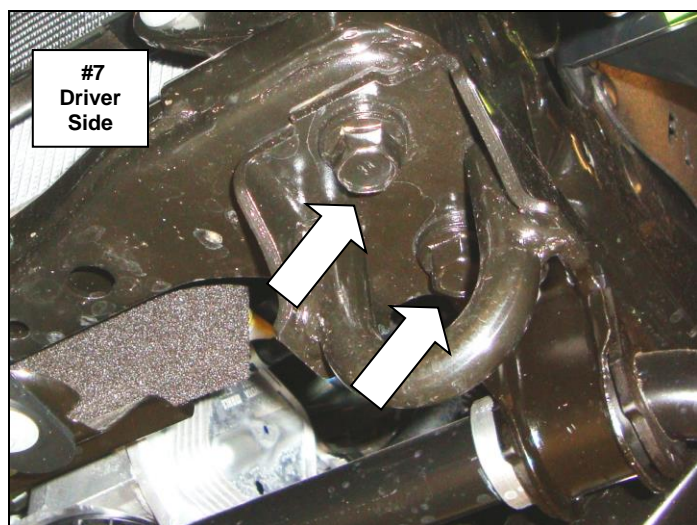

Step-8 Position the driver side extension bracket on the inside of the auxiliary bracket, align the holes in the brackets and secure the extension bracket to the auxiliary bracket using (3) ½” hex bolts, (6) ½” flat washers, (3) ½” lock washers and (3) ½” hex nuts, (Photo 9). Snug but do not fully tighten the nuts and bolts.

Step-9 Position the driver side frame bracket on the end of the frame with the (4) studs protruding through the holes in the bracket, and secure the bracket to the frame using the factory hex nuts, (Photo 10). Snug but do not fully tighten the hex nuts. Repeat steps 2-4 to install the passenger side brackets.

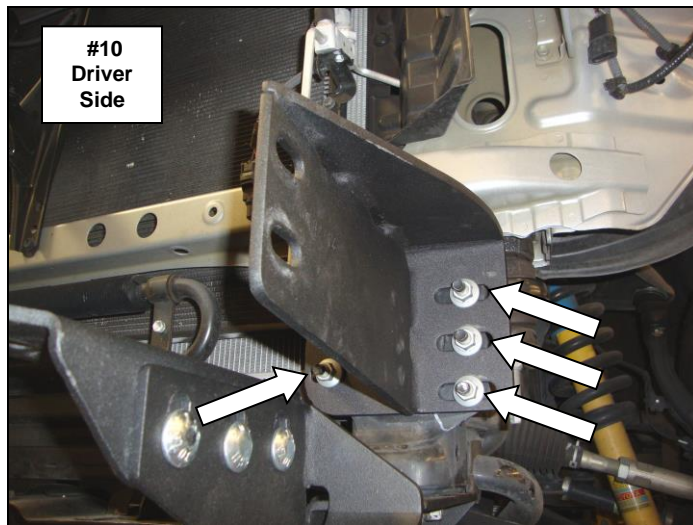

Step-10 Position the mounting plate/winch tray on top of the extension brackets. Secure the mounting plate/winch tray to each frame bracket using (2) ½” x 1 ½” carriage bolts, (2) ½” flat washers, (2) ½” lock washers and (2) ½” hex nuts, and to each extension bracket using (3) ½” x 1 ½” carriage bolts, (3) ½” flat washers, (3) ½” lock washers and (3) ½” hex nut, (Photo 11 & 12). Snug but do not fully tighten the nuts and bolts.

Step-11 Adjust the mounting plate/winch tray and brackets to the forward position, center and level the mounting plate/winch tray with the vehicle frame then tighten all factory hex nuts and supplied nuts and bolts securing the mounting plate/winch tray and frame brackets. Do not tighten the auxiliary bracket nuts and bolts at this time.

If you are installing a winch, place the winch in the mounting plate/winch tray and refer to the winch manufacturer's instructions for installation. Do not install the fairlead at this time.

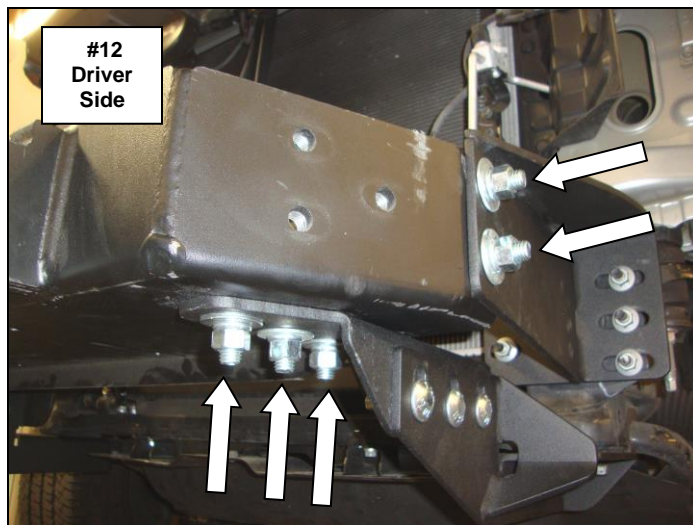

Step-12 With assistance lift the bumper shell up to the vehicle, align the holes in the bumper shell brackets with the weld nuts on the mounting plate/winch tray and secure the bumper shell to each side of the mounting plate/winch tray using (3) 1/2" x 1 1/2" hex bolts, (3) 1/2" lock washers and (3) 1/2" flat washers, (Photo 13). Leave the bolts loose for final adjustment.

Step-13 Locate the large obround hole in the side of the frame next to the front body mount, and install (1) 1/2" T-Bolt in the frame and install (1) vinyl gasket over the threads to prevent the T-Bolt from falling into the frame, (Photo 14).

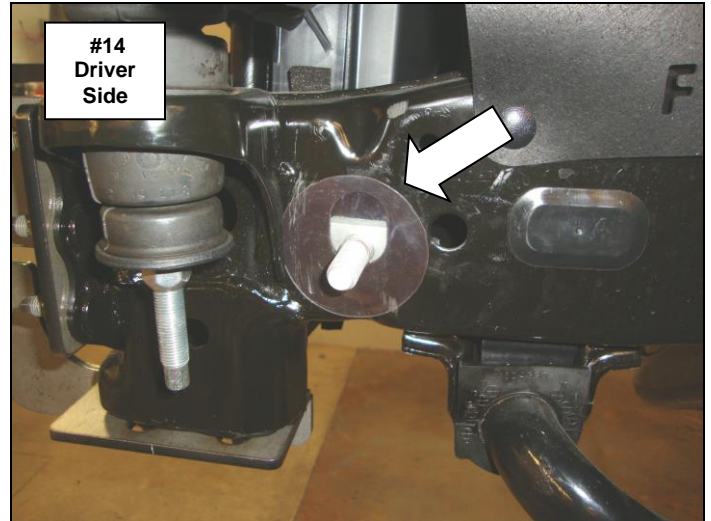
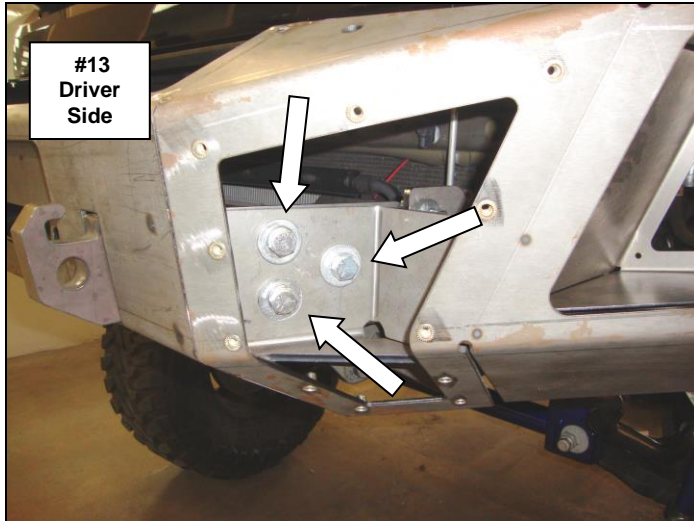

Step-14 Secure the driver side support bracket to the frame using the T-Bolt, (1) 1/2" flat washer, (1) 1/2" lock washer and (1) 1/2" hex nut. Attach the opposite end of the support bracket to the bumper shell bracket using (1) 1/2" x 1 1/2" hex bolt, (1) 1/2" lock washer, (2) 1/2" flat washers and (1) 1/2" hex nut, (Photo 15 & 16).

Repeat steps 13 & 14 to install the passenger side support bracket.

Step-15 With assistance, adjust and hold the bumper shell visual alignment position, then tighten all factory and supplied nuts and bolts. Note: It may be necessary to loosen the nuts and bolts securing the mounting plate/winch tray and brackets.

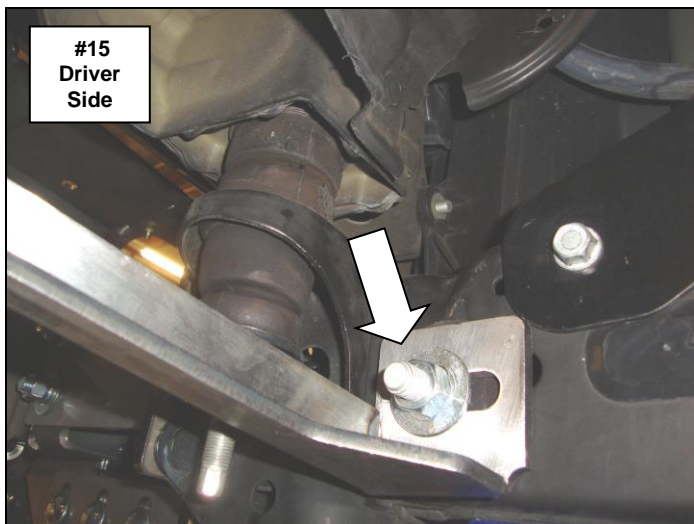

If installing a winch, install the roller fairlead to the bumper shell at this time. Refer to the winch manufacturer's instructions for installation. If installing an optional light bar, install the light bar to the bumper replacement at this time. Refer to the light bar instructions for installation.

Step-16 Install the winch cover and driver and passenger side front vent covers to the bumper shell using the supplied $\frac{1}{4}$ " x $\frac{3}{4}$ " button head bolts, (Photo 17). **Note:** Do not over tighten bolts, reference tightening torque (71 in. lbs.).

Step-17 Install the flush mount light pods to the bumper shell using (4) $\frac{1}{4}$ " x $\frac{3}{4}$ " button head bolts and (4) $\frac{1}{4}$ " nylon lock nuts, (Photo 17).

If your state law requires a front license plate, attach the license plate bracket to the holes in the face of the bumper shell, using the supplied $\frac{3}{8}$ " bolts, washers and nuts, and the license plate to the (2) obround holes in the license plate bracket using the supplied $\frac{1}{4}$ " bolts and nuts, (Photo 18).

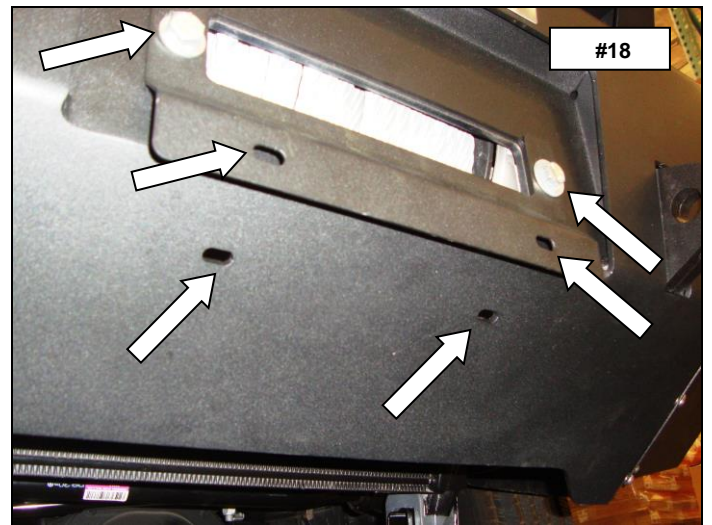
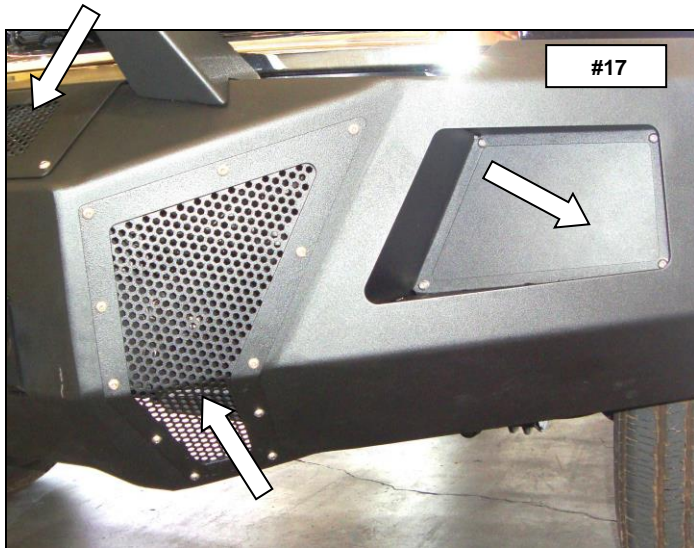

If installing a winch, attach the license plate directly to the (2) obround holes in the lower face of the bumper shell using the supplied $\frac{1}{4}$ " bolts and nuts, (Photo 18).

Remember to check and retighten all factory and supplied nuts and bolts periodically.