

MTO WINCH FRONT BUMPER

2022+ (3RD GEN) TOYOTA TUNDRA

FBTT2-04



TOOLS REQUIRED

- 10mm, 12mm, 13mm, 14mm, 16mm, 17mm Socket
- 10mm, 13mm, 14mm, 18mm, 18mm Wrench
- 4mm, 5mm Allen Bit
- Trim Clip Tool
- Flat Head, Philips Head Screwdriver
- Angle Grinder
- Scissors or Shears
- Boxcutter Blade or Knife
- File or Sandpaper
- HD Double Sided Tape, Painters Tape
- Measuring Tape
- Sharpie

SKILL LEVEL

- Intermediate/Difficult
- 2 persons

Intermediate skill level required. Assistance is necessary for installation.

TIME REQUIRED

- 4-6 Hours

Time to install this should take between 4-6 hours based on experience.

WARNINGS/CAUTIONS BEFORE STARTING INSTALLATION

Before you install this kit – Read and understand all instructions, warnings, cautions, and notes contained in this installation instruction guide. Consult your vehicle owner's manual for proper disconnection of electrical and lifting of vehicle if required for installation of this product.

This install may require some technical skills and knowledge of basic mechanical work. If you do not feel that you are capable of performing this install please take this product to a trained professional.

After reading this guide please contact us with any questions or concerns before installing product.
Customer Service: 855-680-9595

DV8 Offroad is not responsible for any bodily injury or harm to you or your vehicle as a result of an improper install.

Proper installation of this kit required knowledge of the factory recommended procedures for removal and installation of original equipment components. We recommend that the factory shop manual and any special tools needed to service your vehicle be on hand during the installation. Installation of this kit without proper knowledge of the factory recommended procedures may affect the performance of these components and the safety of the vehicle

- Always wear eye protection when operating power tools

Inspect all contents of this package to make sure product is not damaged and all installation hardware has been included. If parts are missing from kit, please be prepared to provide the following information

1. Name of purchase location
2. Bar Code on side of box
3. Date above bar code
4. Date inside box cover



INSTALLATION **MANUAL**

FACTORY BUMPER UNINSTALL

STEP 1 | Use a trim clip tool and 10mm socket to remove the fasteners securing the inner fender to the vehicle.

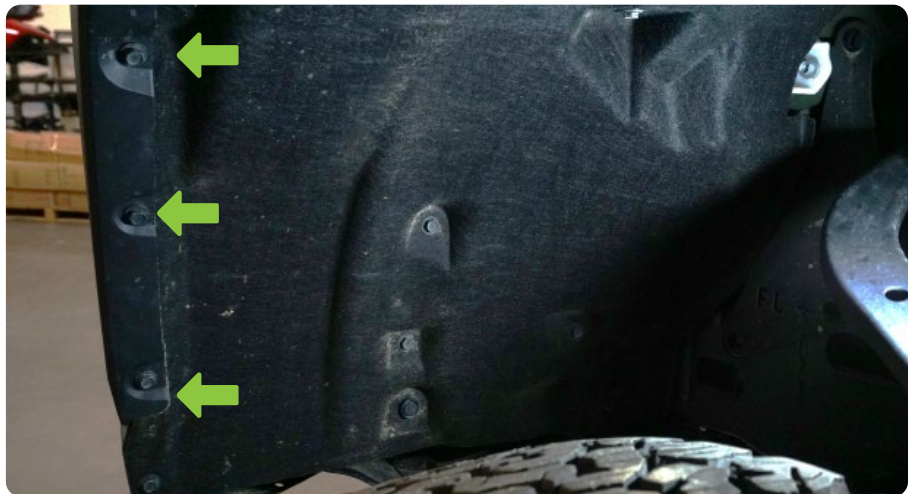

INSTALLATION MANUAL

STEP 2 | Pull back the inner fender to access the front bumper once the inner fender fasteners are all removed.



STEP 3 | Using firm pressure, pull the fender flare away from the truck to the side to release the clips.

Once released, pull the side of the bumper down slightly and to the side to release the clips between the bumper and fender. Take your time to not break any of these clips.



STEP 4 | Reach behind and underneath the bumper to remove the black plastic trim by pressing out the clips from the inside.

You can gently pull from the outside as well, but do not allow them to bend or the clips will break.



INSTALLATION MANUAL

STEP 5 | Use a trim clip tool to remove the push clips next to the wiring plugs located next to the headlights at both ends of the vehicle.

Then disconnect the plugs.

Note: Number of wire connectors may vary based on options/trim level of the vehicle.



STEP 6 | Disconnect the wiring plug located between the bumper and radiator in the center section of the vehicle.



INSTALLATION MANUAL

STEP 7 | Use a trim clip tool to remove the fasteners securing the wiring plugs located behind the bumper in the fender well area on both sides of the vehicle.

Then disconnect the plugs.

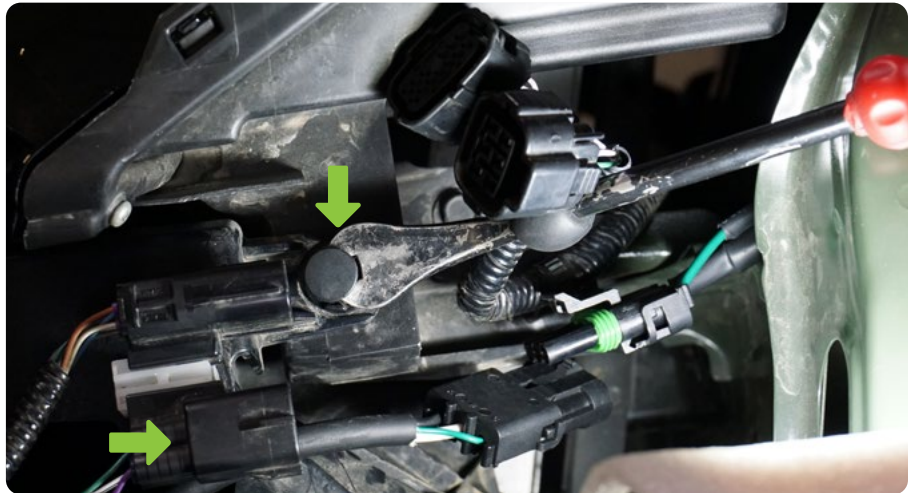

STEP 8 | Disconnect the wiring plugs located behind the grille on the passenger side of the vehicle underneath the grille's upper mounts.



INSTALLATION MANUAL

STEP 9 | Use a 10mm socket to remove the bolts securing the grille to the vehicle.

These are located:

- Along the radiator frame brace under the hood.
- Underneath the vehicle along the bottom of the bumper.
- Behind the trim pieces on both sides of the vehicle underneath the headlights.

Note: Assistance is recommended to prevent damage to the grille/bumper.

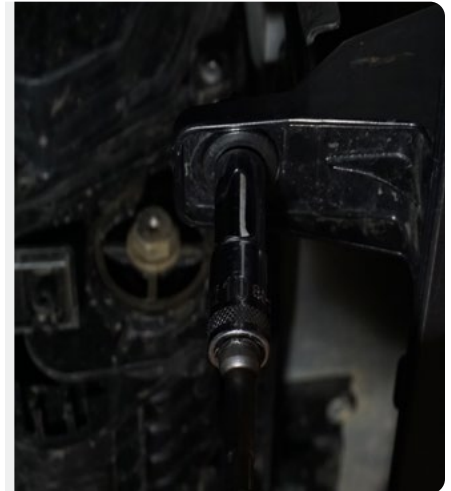
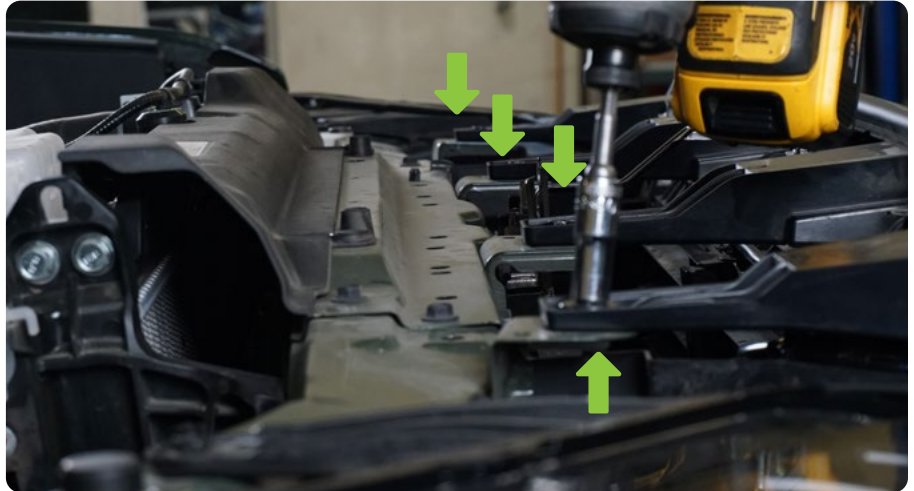

STEP 10 | Remove the wiring connector from the air dam motor, and use a trim clip tool to undo the clip securing the wiring harness to the motor.

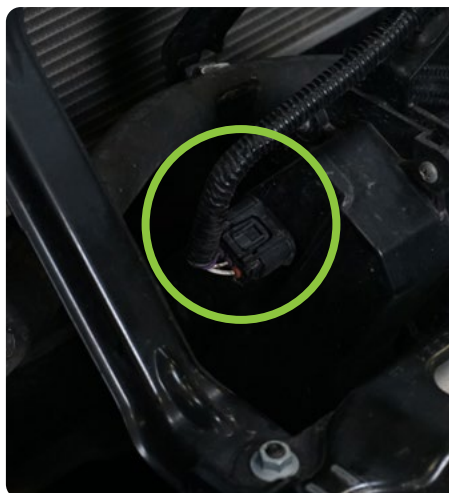

INSTALLATION MANUAL

STEP 11 | Use a 17mm socket or wrench to remove the bolts securing the crash bar.

Then set the crash bar and braces off to the side.

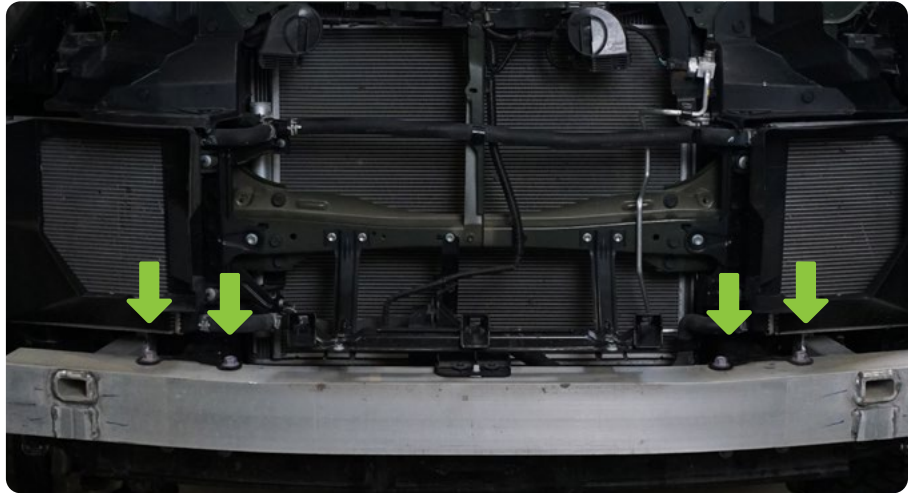

STEP 12 | Use a 10mm socket to remove bolts securing the vertical cross braces from the vehicle.



INSTALLATION MANUAL

STEP 13 | Use a 10mm socket to remove the bolt securing the cooling hose bracket and set off to the side.



STEP 14 | Use a 12mm socket to remove the bolts securing the skid plate if you have one, and set it off to the side.

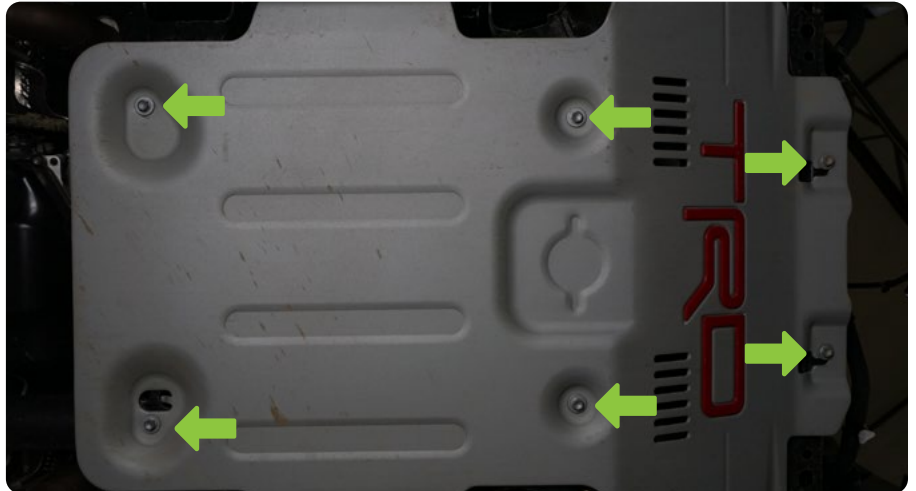

INSTALLATION MANUAL

Begin by unpacking all items and inspecting for missing pieces or damage. If you have any concerns, please contact the company the product was purchased from. Extra hardware may be included with the product.

HARDWARE INCLUDED

- | | |
|-------------------------|--------------------------|
| (6) M14x35 Hex | (7) M8 Flat Washers |
| (12) M14 Flat Washers | (1) M8 Wide Flat Washer |
| (6) M14 Nylon Lock Nuts | (4) M8 Nylon Lock Nuts |
| (6) M12x30 Hex | (5) M6x25 Allen |
| (12) M12 Flat Washers | (6) M6x20 Allen |
| (6) M12 Nylon Lock Nuts | (5) M6 Nylon Lock Nuts |
| (6) M10x30 Hex | (13) M6 Flat Washers |
| (6) M10 Flat Nuts | (3) M6 Split Washers |
| (6) M10 Flat Washers | (5) M6 Wide Flat Washers |
| (3) M8x20 Allen | (1) M6x30mm Hex |

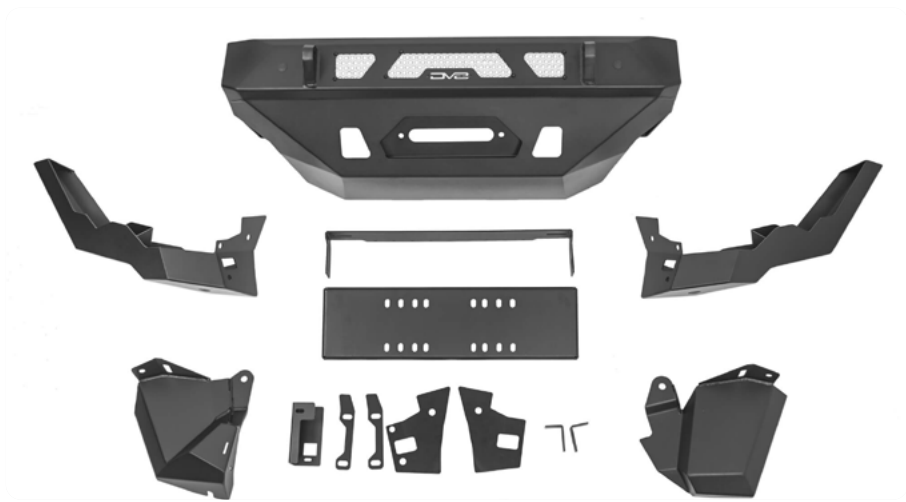

STEP 15 | Apply the provided foam to the wings and install them on the bumper using the provided M12 hardware with 18mm and 19mm wrench. Tighten these bolts, then loosen them up just enough so that you can adjust the wings once the bumper is on the vehicle.



STEP 16 | Install the M10 flat nuts on the bumper by pressing them into place.

These nuts have lots of tension. We recommend using a flat head screwdriver or similar to remove some tension from the flat nuts, so they can move somewhat freely once they are pressed onto the bumper. This will help when it is time to install the bumper on the vehicle.



INSTALLATION MANUAL

STEP 19 | If you are installing a fairlead, do so at this time using the hardware provided with the fairlead.



STEP 17 | Install the winch plate using the provided M14 hardware and a 21mm and 19mm wrench.

If you are running a winch, install it at this time using the hardware provided with the winch.



STEP 18 | If you are running pod lights, install them at this time using the hardware provided with the lights.

Note: We are using 3" elite series pod lights for our install.



INSTALLATION MANUAL

STEP 20 | If you are running a light bar, install lightbar on to the provided brackets using the hardware provided with the light.

Install the light bar brackets on the bumper, then align and secure using the provided M6x20 hardware with a 4mm allen bit and 10mm wrench.

Tip: The M6x20 is the shorter version of the smallest bolt.

Note: We are running a 20" DV8 elite light bar.



STEP 21 | Install the bumper onto the vehicle using the provided M10 hardware with a 16mm socket. Utilize the provided spacer plate between the top section of the bumper and mount.

Note: Assistance is highly recommended for ease of install, to prevent injury, and to prevent damage to the product or vehicle.

Run the winch line out of the bumper now while there is easy access.

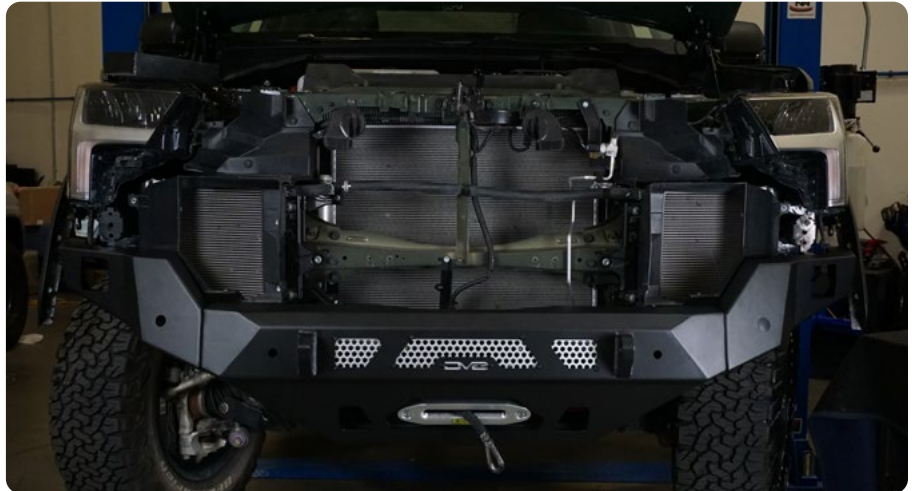

INSTALLATION MANUAL

STEP 22 | On the factory bumper, remove the sensors by gently spreading the outside tabs. Remove the sensor plugs using a trim clip tool. You can use light heat to help this process.

Tip: These plugs and sensors must be installed on the new bumper in the same location that they were removed. Use painters tape and a sharpie to mark both the plug, and sensors factory locations.

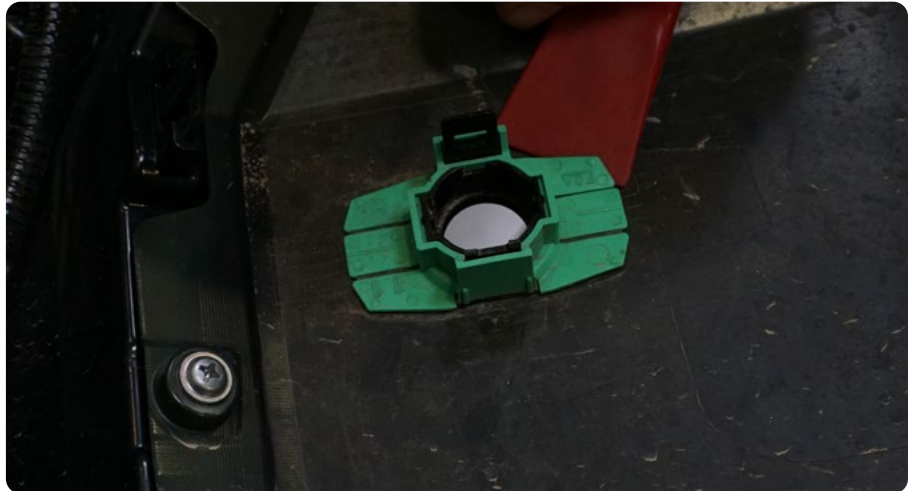
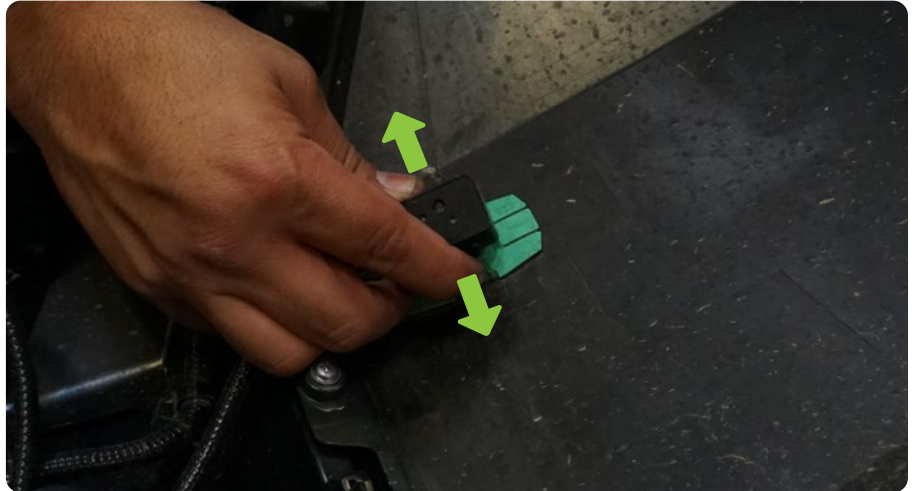

STEP 23 | Clean the residue off the sensor plug using a blade so that when installed, it will sit flush.

Cut an appropriate amount of double sided heavy duty tape and apply to the side of the sensor that will touch the bumper.

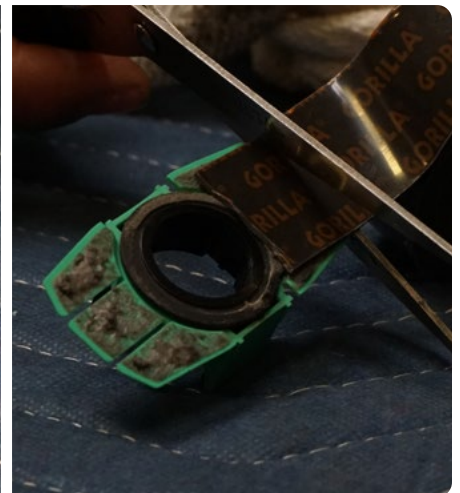

INSTALLATION MANUAL

STEP 24 | Remove the sensor wiring harness from the factory bumper by unclipping the fasteners securing it using a trim clip tool.

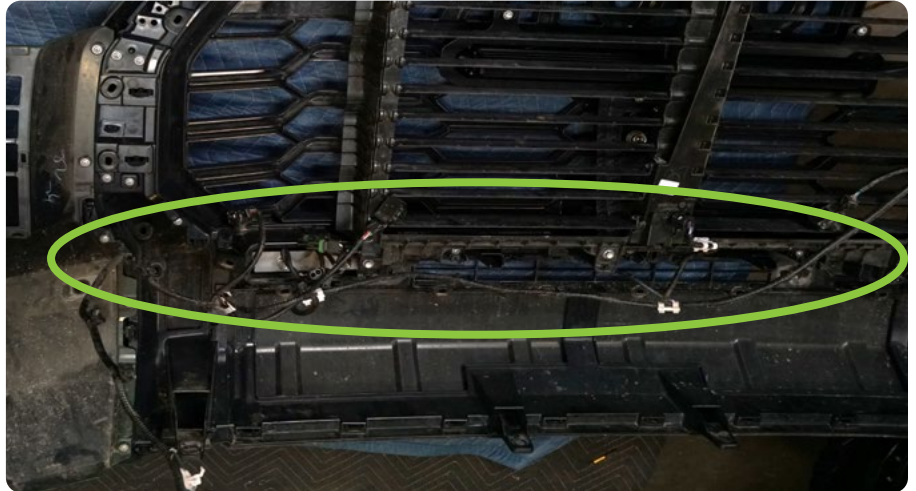

STEP 25 | Install the sensor plugs into the bumper correlating to the factory locations.

Tip: Reference the marked painters tape.



STEP 26 | Use a philips head screwdriver to remove the screws on each side of the bumper to remove the side trim pieces.

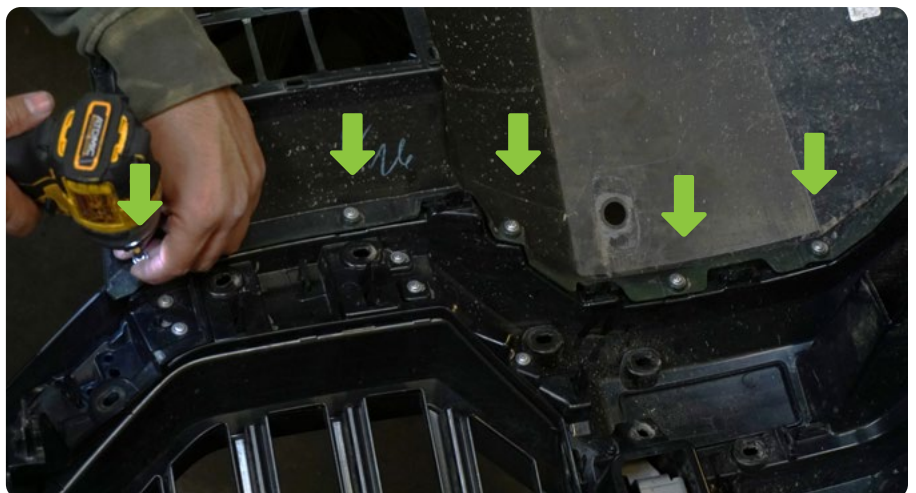

INSTALLATION MANUAL

STEP 27 | Use a 10mm socket to remove the bolts located at the top and bottom of the shutters and set off to the side.

Disconnect the adaptive cruise control and then use a philips head screwdriver to remove it from the grille if equipped.

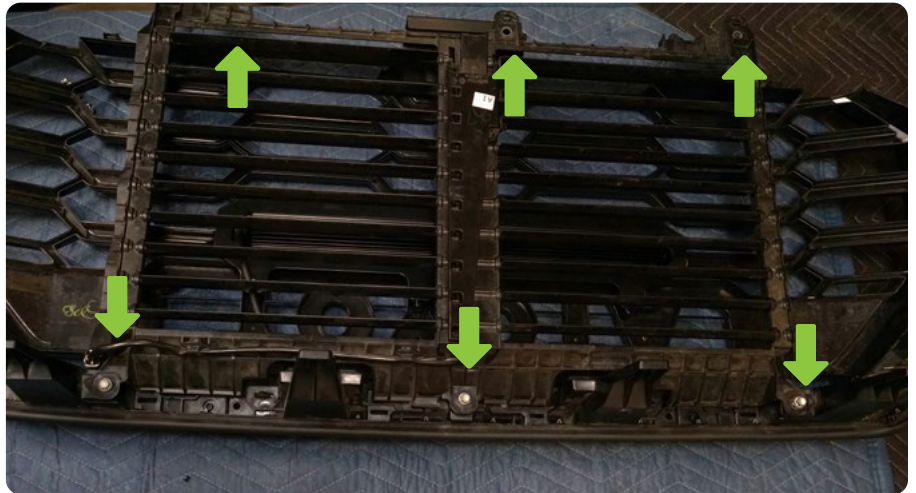

STEP 28 | Remove upper mounting bracket from the grille by pulling it away from the grille to release the clips.

Note: Be careful to not pull at an angle, as it may break the clips.

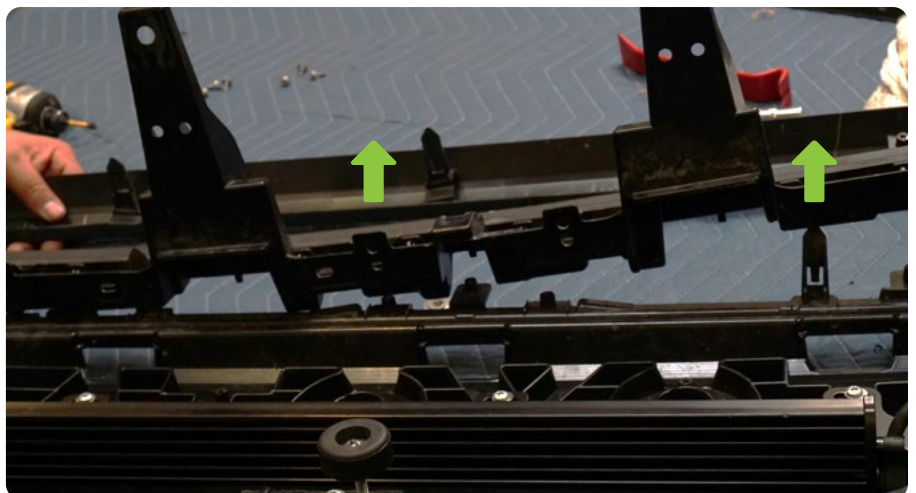

INSTALLATION MANUAL

STEP 29 | Use an angle grinder to grind the bottom mounting tabs off so they are flush with the rest of the grille.

Note: The remainder of this install involves lots of cutting. Always be patient and take precise measurements when prompted. It is better to be conservative when cutting.



STEP 30 | Use an angle grinder to grind a small section off the bottom corners of the grille.

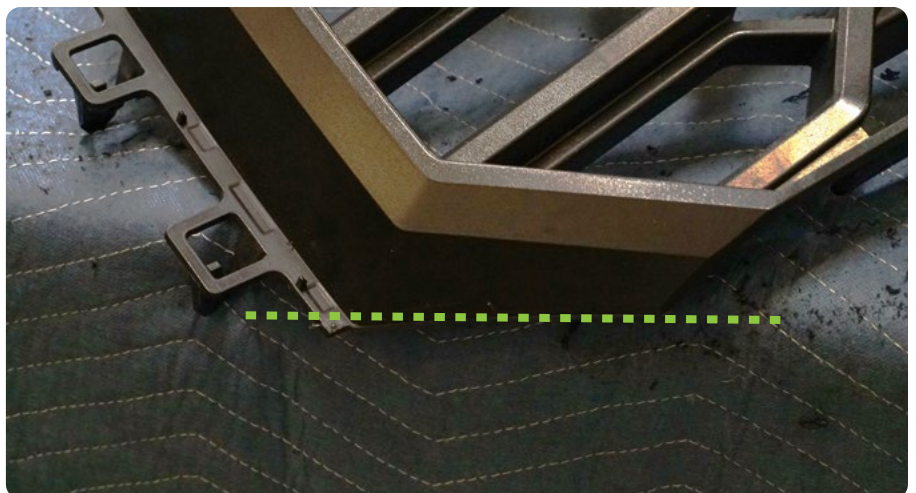

INSTALLATION MANUAL

STEP 31 | Trim the bottom section of the upper mounting bracket. Everything below the bended section will be cutoff, leaving the mounting holes.

Clean up any rough edges.



STEP 32 | Install the upper mount that mounts to the vehicle back onto the grille by clipping it back into place on the grille.



INSTALLATION MANUAL

STEP 33 | Secure the adaptive cruise control using the factory screw and philips head screwdriver.

Place the spacers onto the ACC and then place the provided spacer bracket on top.

Use a 4mm allen bit and provided M6x25 hardware to secure.

Tip: The M6x25 bolt is longer version of the smallest bolt. Only two of them are provided.



STEP 34 | Secure the shutters to the provided bracket using the provided M8 hardware with a 5mm allen bit and 13mm wrench.



STEP 35 | Use a 10mm socket and the factory bolts to install the shutters.

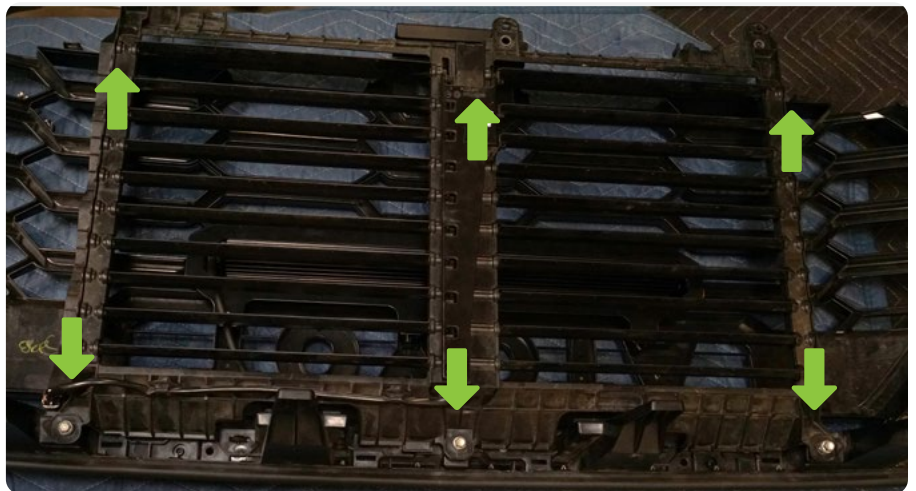

INSTALLATION MANUAL

STEP 36 | Install the “L” shaped brackets on the bottom of the grille.

These should be installed so that the flat section will touch the bumper when installed. (Long slot will mount to these holes)

Use the provided M8 hardware with a 5mm allen bit and 13mm wrench.

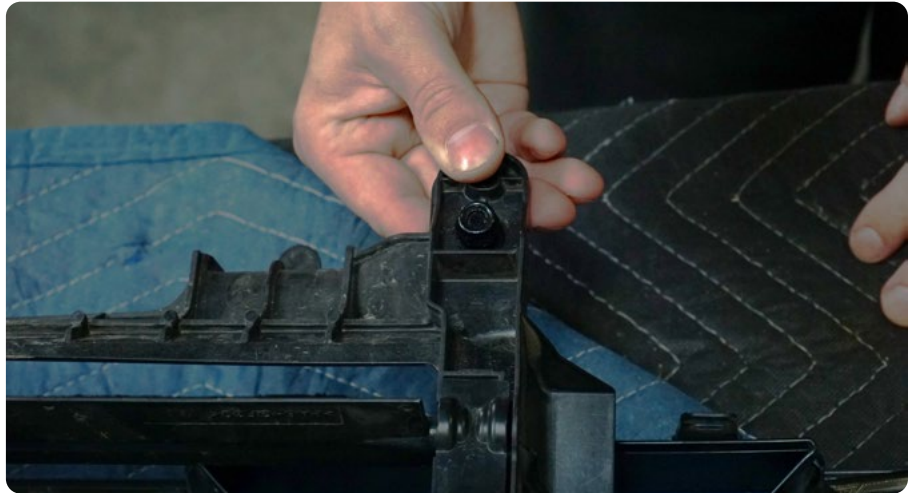

INSTALLATION MANUAL

STEP 37 | On the air dam motor use a trim clip tool to remove the cap.

Then use a 14mm socket and wrench to remove the bolts and nut securing the arm.



STEP 38 | Remove the black caps, the white plastic spacers and the spring from the inside, and set the arm off to the side.

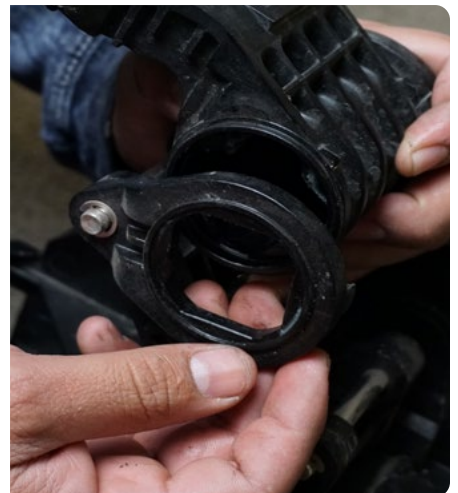
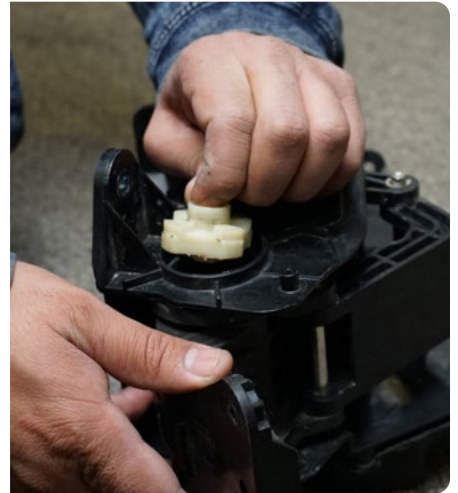

INSTALLATION MANUAL

STEP 39 | Cut the flat section off of the arm as shown.



STEP 40 | Place the arm back into the motor and install the spring, white plastic spacers, and black caps. Then secure using the factory hardware with a 14mm wrench and socket.

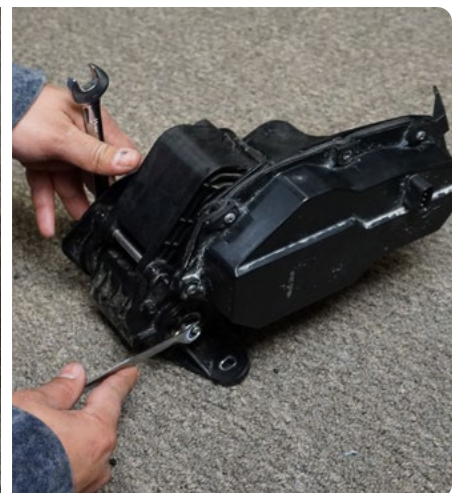

INSTALLATION MANUAL

STEP 41 | Trim the plastic section with the two factory mounting holes off of the motor as shown.

HOLES WITH THE ARROWS WILL BE REUSED, DO NOT CUT THESE

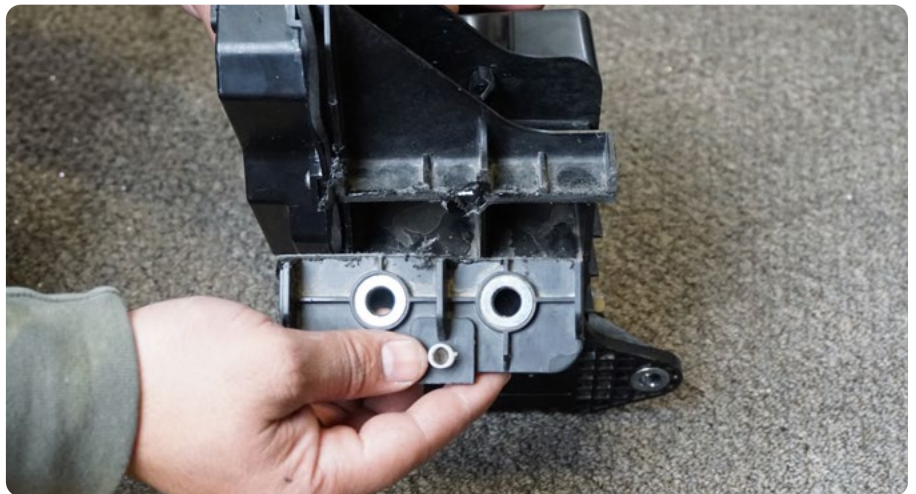
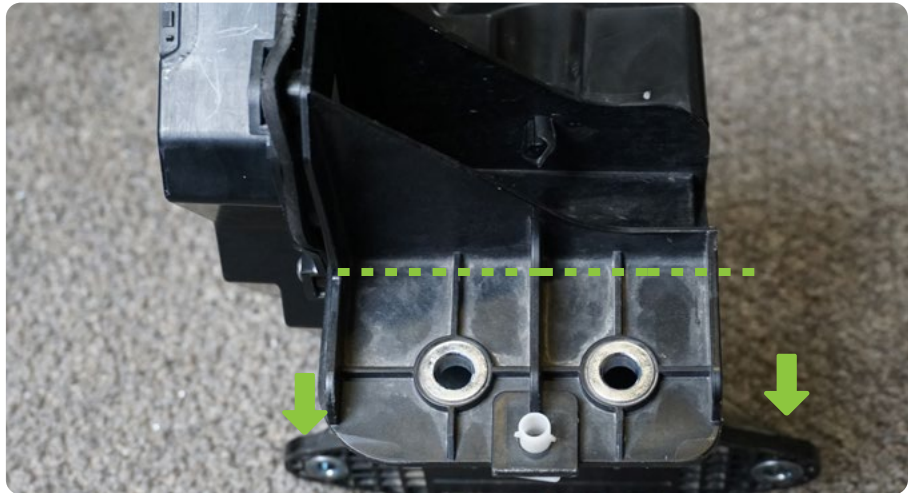

STEP 42 | Trim the small remaining mounting tab off the motor as shown.



INSTALLATION MANUAL

STEP 43 | Replace cap on the air dam motor.



STEP 44 | Use a 10mm socket to remove the bolt securing the cooling hoses to bracket located in front of the radiator on the passenger side.



INSTALLATION MANUAL

STEP 45 | Remove the cooling hoses running in front of the radiator from their plastic retaining clips.



STEP 46 | Use a 10mm socket to remove the bolt securing the vertical cross brace. Slip the cooling hose behind the cross brace and re-secure using the factory hardware.



INSTALLATION MANUAL

STEP 47 | On the passenger side, push back on the hose mounting bracket to give the hoses some slack and then re-secure the hoses using the factory hardware and a 10mm socket.

Replace the upper cooling hose in its plastic retaining clips

Tip: Zip tie the lower cooling hose to the center brace at this time ensuring it clears the winch if you are running one. Hoses should not be too taught or too loose and should not collide with anything.



STEP 48 | Use the provided M6 hardware with a 4mm allen bit and 10mm wrench to secure the air dam motor to the provided bracket.

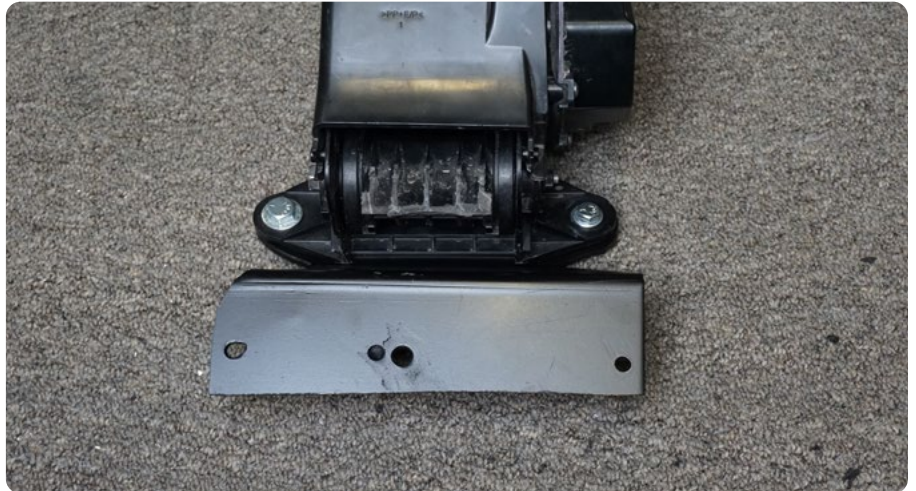

STEP 49 | Install the air dam bracket onto the horizontal cross brace using the provided M6 hardware and a 4mm allen bit. Connect the air dam motor wiring plug.

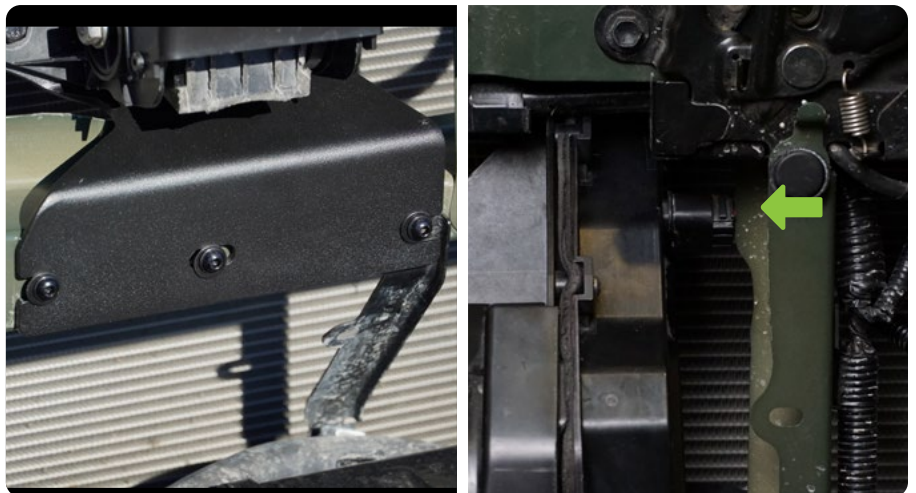

INSTALLATION MANUAL

STEP 50 | Secure air dam motor wiring harness to vertical center cross brace using the factory clip.

Note: Air dam motor should have a healthy gap between it and the radiator. The radiator hose running behind the air dam motor should not be too tight or too loose, and should also have a gap between it and the radiator. Use a zip tie for additional security, if desired.



STEP 51 | Place the wiring harness into the bumper and run the wires so that the sensors are at their approximate location of install. Secure the wiring in a safe location.

Install the sensors into the new bumper at the same locations they were on the factory bumper by pressing until the “clip” into place.

Tip: Reference the painters tape you marked on each sensor.

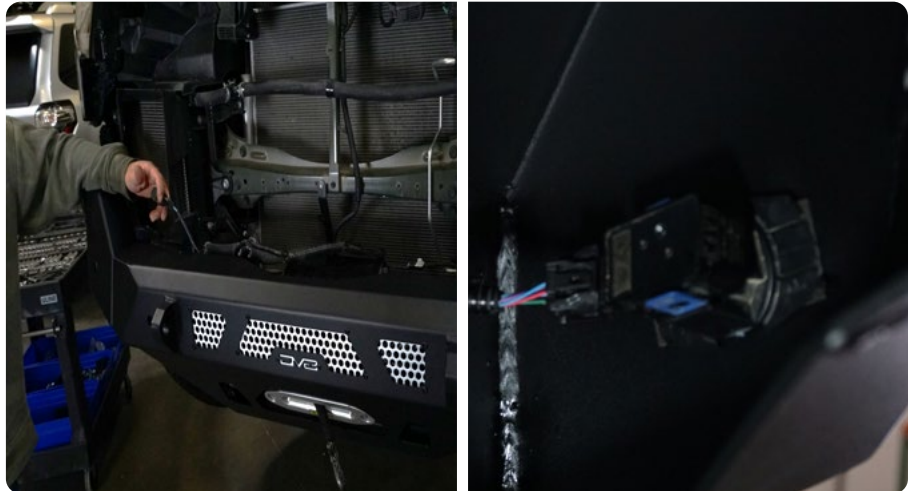

STEP 52 | Have a friend hold the grille in its approximate location of install while re-connecting the adaptive cruise control.

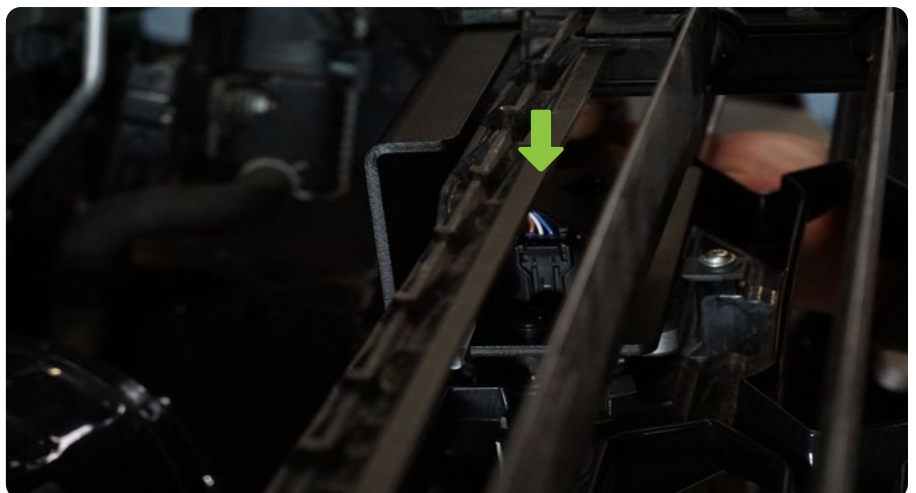

INSTALLATION MANUAL

STEP 53 | Secure the top section of the grille to the radiator frame using the factory hardware and mounting holes with a 10mm socket.



STEP 54 | Use the provided M6 hardware and a 4mm allen bit to secure the lower section of the grille to the bumper. The same tabs from step 36.

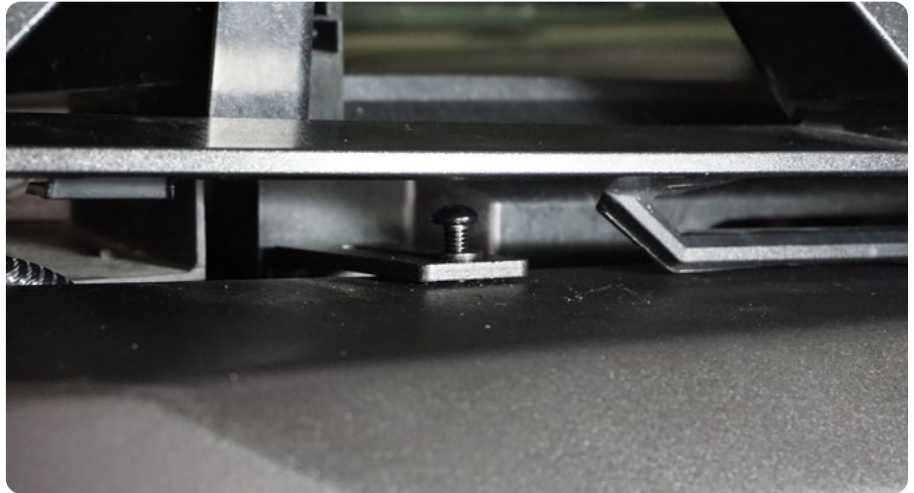

STEP 55 | Re-install factory clips located next to the wiring plugs at both ends of the vehicle behind the headlight.

Then re-connect the wiring to the plugs located at both ends of the vehicle behind the headlight. (From Step 5)

Note: The number of wires to re-connect may vary based on options/trim.

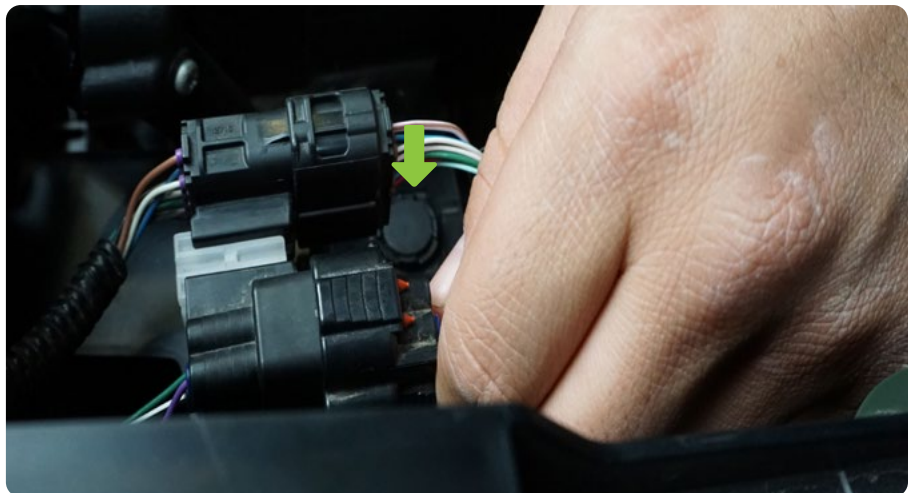

INSTALLATION MANUAL

STEP 56 | Re-secure wiring harness to the grille using factory clips by applying pressure until it “clips” into place.



STEP 57 | Connect the wiring located behind the bumper in the fender well on both passenger and driver side of vehicle. (From Step 7)

Connect the wiring to the plug located on the shutters. (From Step 6)

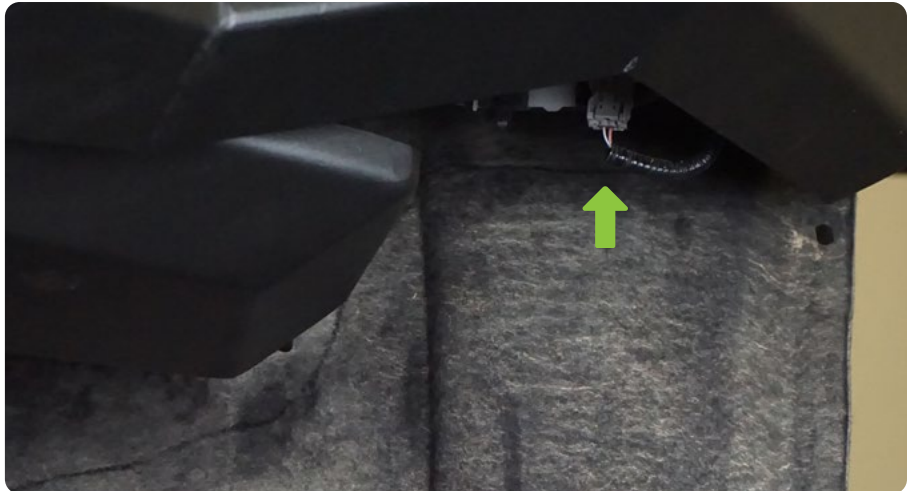

STEP 58 | Connect the wiring located on the passenger side of the vehicle underneath the upper mounting bracket on the grille. (From Step 8)

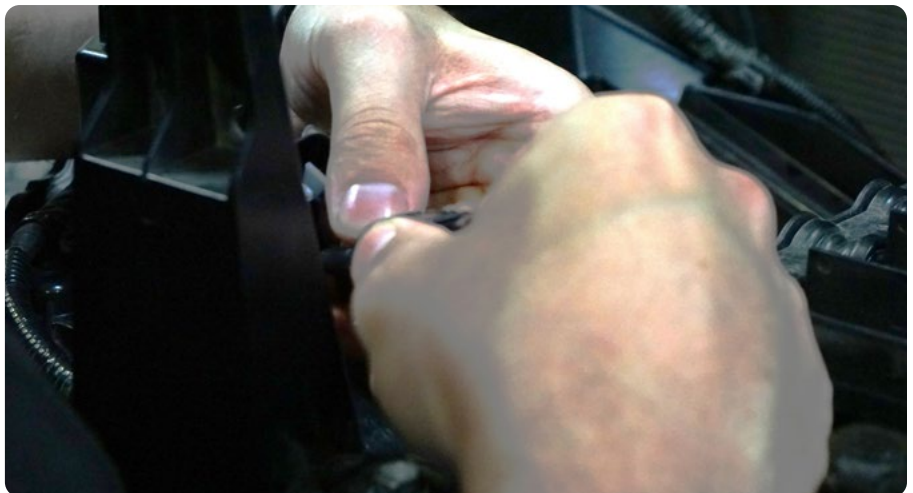

INSTALLATION MANUAL

STEP 59 | Install the outer trim of the grille by applying pressure to press the clips into place.



STEP 60 | Vehicle must be resting on the ground and not on a lift or jack stands when cutting.

Adjust the wings on the bumper to and when you are satisfied with fitment, secure them using an 18mm and 19mm wrench. The wings will work with the measurements as a guide for cutting.

To trim the side trim pieces, mark these measurements using a measuring tape and painters tape or similar.

When you are confident with the measurements taken, use an angle grinder to begin the cut. (Other cutting tools can be used as well)

Test fit the trim piece after cutting to determine whether or not to cut more material off.

Pro Tip: These measurements are a good guideline but actual measurements may vary based on vehicle. Best practice is to leave a little more material than you think is necessary.

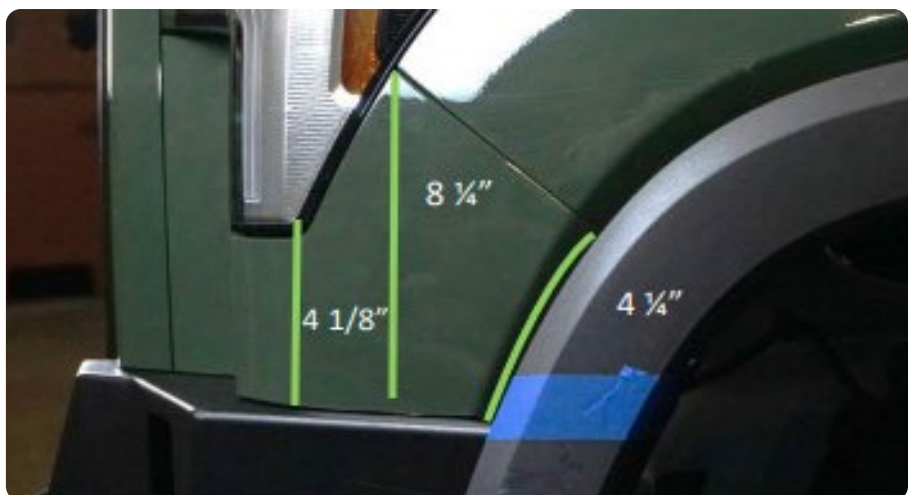

INSTALLATION MANUAL

STEP 61 | Secure the side trim pieces from behind the bumper using the factory clips and screws with a philips headscrewdriver.

Utilize the screw from the tab under the headlight to secure side trim pieces by screwing it into the tabs mounting hole.



INSTALLATION MANUAL

STEP 62 | Mark the fender flare trim with painters tape, using the bumper and fender as a guide.

Clean up any rough edges and secure it by applying pressure until it “clips” into place.



STEP 63 | Remove the factory bolt in front of the wheel and behind the bumper using a 17mm socket. Install caps using the factory bolt and mounting hole.

Once installed, use a 18mm and 19mm to remove one of the bolts securing the wing and re-install it so that it is also securing the covers.

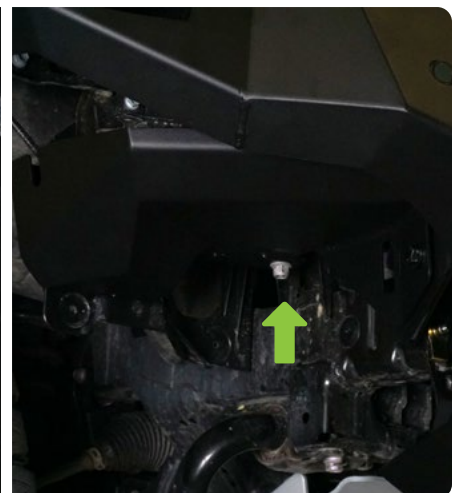

INSTALLATION MANUAL

STEP 64 | Use scissors or a blade to trim the inner fenders using the mounting points as a guide.

Once finished, re-install the factory clips and bolts using a 10mm socket to secure the inner fender to the vehicle.



STEP 65 | Re-install the skidplate using the factory hardware and a 12mm socket. Double check all hardware is secure and that all wiring is connected.



STEP 66 | Congrats! You are finished with the install of the 2022+ Toyota Tundra MTO Front Bumper.

