



Installation Instructions
717893
2019-21 GM SILVERADO/SIERRA 1500
5.3L ENGINE

Crew Cab & Double Cab

This kit does NOT fit crew cab 2WD with 2 piece driveshaft or trucks with factory dual tailpipes.

OVERVIEW:

1. Take a moment to read and understand these instructions before installing your Flowmaster performance system.

NOTE: Please inventory all parts now before continuing and if necessary, report any missing items to our tech line. This will avoid potentially stranding your vehicle until any missing replacement parts arrive.

ITM #	PART #	DESCRIPTION	QTY.
8	ST507B	Tips	2
N/A	PK979	Hardware Package includes:	1
9	226HA	Left Frame Hanger	1
10	HA566	Backing Plate	2
11	HA168	Rubber Hanger	1
12	MC300BS	3" Band Clamp	2
13	MC250BS	2½" Band Clamp	4
14	HW220	¾"-16 x 4" Bolt	1
15	HW303	¾" Flat Washer	1
16	HW309	¾" Lock Washer	1
17	HW103	¾"-16 Nut	1
18	HW502	7/16" Hanger Keeper	2
19	HW503	½" Hanger Keeper	4

ITM #	PART #	DESCRIPTION	QTY.
1	26740M	Inlet Pipe	1
2	TB700M	Extension Pipe	1
3	72288-Z	Muffler	1
4	86542M	Left Front Tailpipe	1
5	86543M	Right Front Tailpipe	1
6	86544M	Left Rear Tailpipe	1
7	86545M	Right Rear Tailpipe	1

REMOVE STOCK EXHAUST SYSTEM:

2. Raise vehicle up on a hoist or rack to working height. If you don't have access to a hoist or rack, support vehicle with jack stands.

WARNING:
 Avoid serious burns! Allow your vehicle time to cool completely before touching any factory engine components.

To ease preparation and installation of your new kit:

- Apply penetrating lubricant to mounts, bolts and clamps before you remove them.
- Use stands as necessary to support parts as you detach them from your vehicle and again as you install new parts.

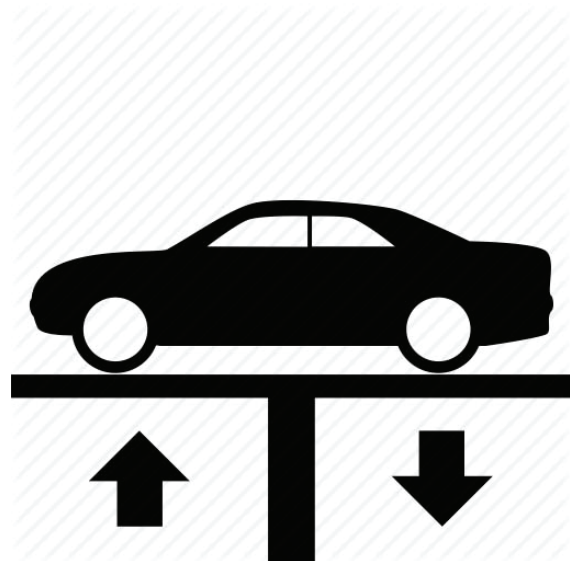

- Cut tailpipe at muffler exit. Disassemble hanger wires from isolators and remove tailpipe section from vehicle.



- Support muffler and disassemble wire hangers from isolators. Loosen ball clamp, disconnect inlet pipe at cat. converter and remove exhaust system. Release tab to remove clamp from pipe and retain it for later use.

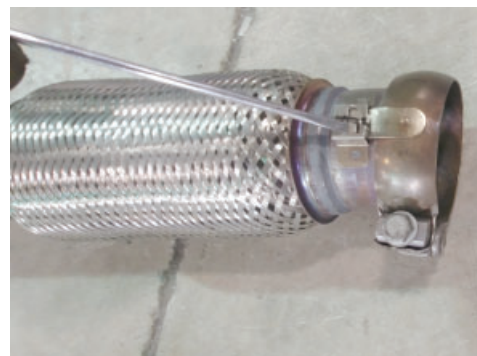
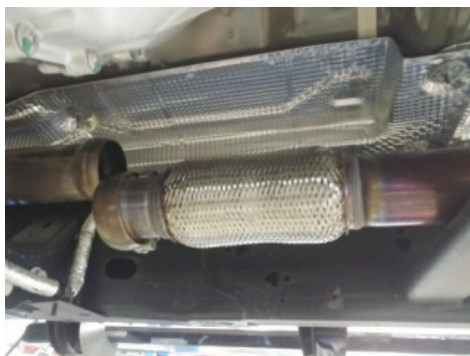

INSTALL FLOWMASTER EXHAUST SYSTEM

- Remove nuts from stock and Flowmaster clamps, apply anti-seize compound to bolts and re-install nuts.

NOTE: The image in this step is intended for illustrative purposes only and may or may not accurately reflect components included in your kit.

- Every slip fit connection in this kit must seat 3" deep except for muffler connections which must seat 2" deep. Find all slip fit components in your kit and mark them accordingly so your Flowmaster exhaust system fits properly onto your vehicle.



7. Find your vehicle within specifications listed below, and if necessary, apply corresponding modifications to ensure it will install properly.

WHEEL BASE	BODY STYLE	BED LENGTH	INLET ASSY:
148"	Crew Cab	5'8	Inlet Pipe only
157"	Crew Cab	6'5	Inlet+Extension
148"	Double Cab	6'5	Inlet Pipe only

8. Place clamp (removed step 4) onto **inlet pipe (1)**. Connect inlet pipe to catalytic converter and mount wire hanger into factory isolator. Tighten clamp just enough to allow for adjustment.

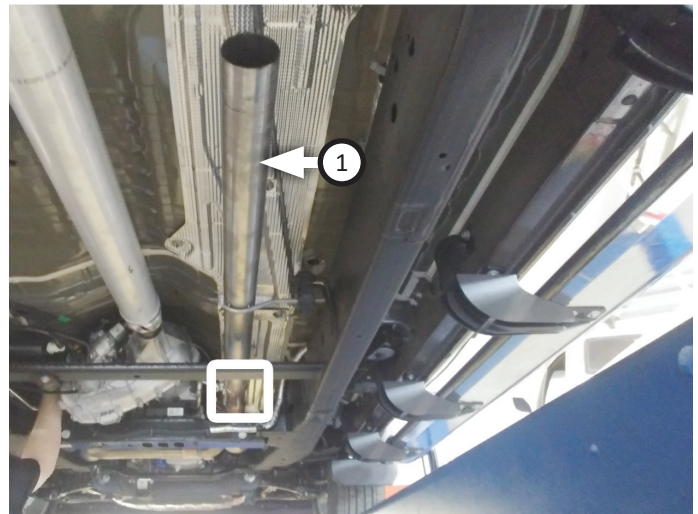

9. If applicable, place **clamp (12)** onto **extension (2)** then connect it to inlet pipe. Tighten clamp just enough to allow for adjustment.

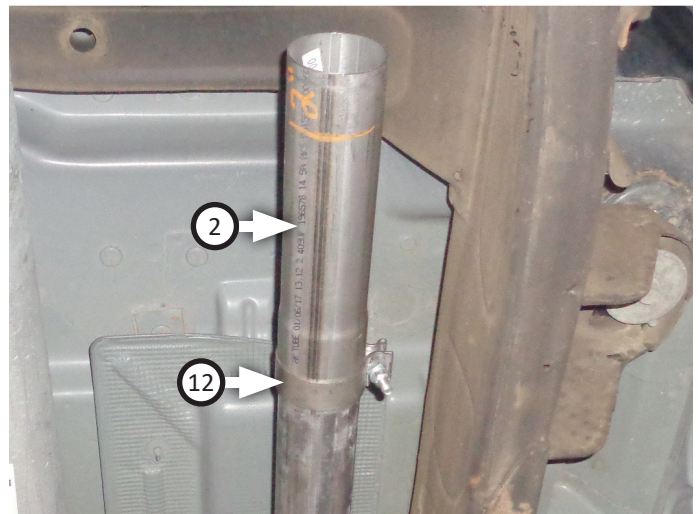

10. Place **clamp (12)** onto **muffler (3)** then connect it to inlet/extension pipe. Tighten clamp just enough to allow for adjustment then place (x2) **clamps (13)** onto muffler outlets.

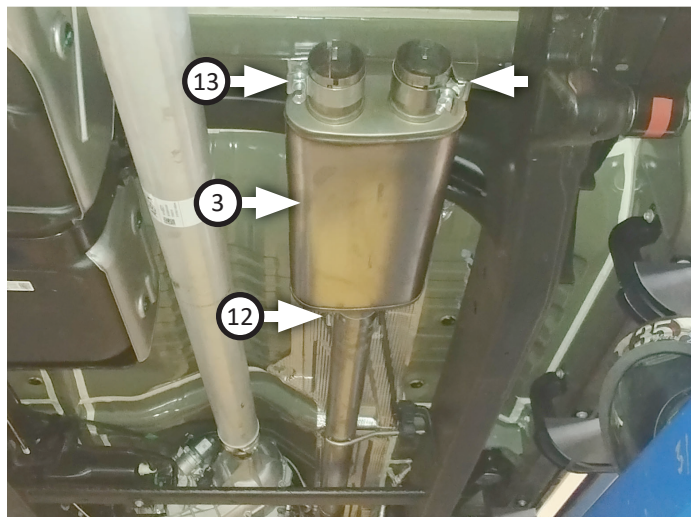

11. Fasten **frame hanger (9)** to vehicle (behind rear driver tire) using **bolt (14)**, (x2) **backing plates (10)**, **flat washer (15)**, **lock washer (16)** and **nut (17)** as shown. Then hang **rubber hanger (11)** on frame hanger end.

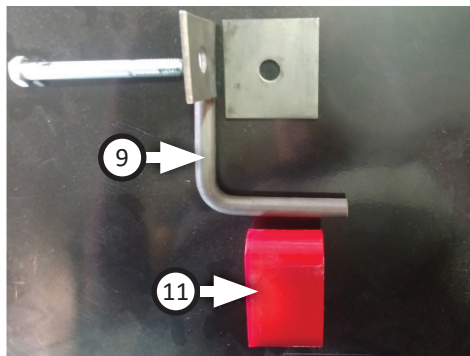
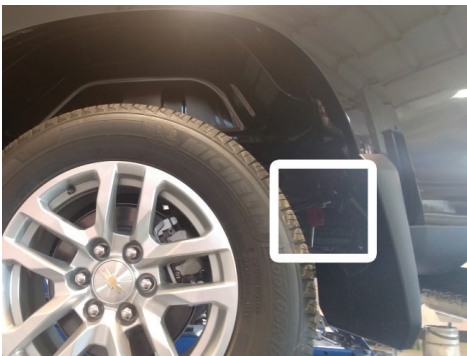

12. Route **left front (4)** and **right front (5)** tailpipes over axle then connect them to muffler. Insert their wire hangers into isolators and tighten clamps just to hold parts.

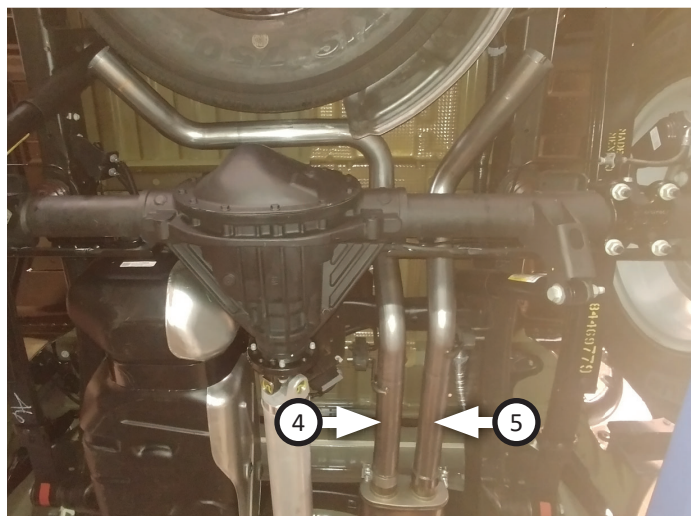

13. Place a **clamp (13)** onto each **left (6)** and **right (7)** rear tailpipe then connect them to corresponding front tailpipes. Insert wire hangers into rubber hanger then tighten clamps just enough to hold parts.

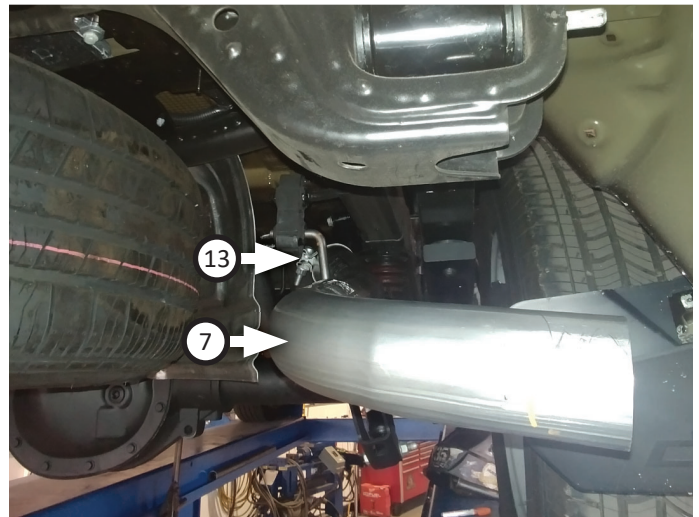
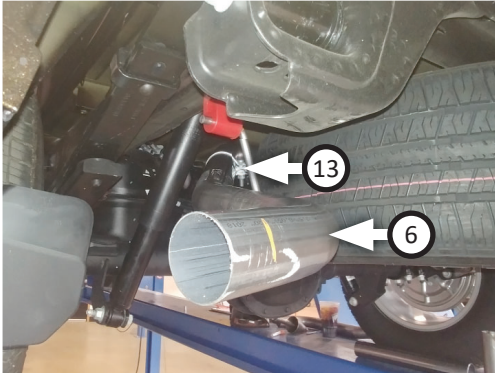

14. Place (x2) **tips (8)** onto rear tailpipes and tighten inlets. Rotate exit pipes and tips to desired distance from body or bumper, so angle cut on tips are properly positioned.
15. Adjust exhaust components for fit; maintaining $\frac{1}{2}$ " clearance and compensating for suspension, travel and vibration, then tighten all clamps. Finally, fit $\frac{7}{16}$ " (**18**) and $\frac{1}{2}$ " (**19**) **hanger keepers** (x6) onto each sideways hanger.
16. Recommended: Secure slip-fit connections with a 1-inch tack weld then spray high-temp paint over each weld to prevent rust and premature corrosion.



Congratulations, the installation of your FLOWMASTER performance exhaust system is now complete!





Installation Diagram
717893
2019-21 GM SILVERADO/SIERRA 1500
5.3L ENGINE
Crew Cab & Double Cab

This kit does NOT fit crew cab 2WD with 2 piece driveshaft or trucks with factory dual tailpipes.

