



Installation Instructions
817819
 2018-21 JEEP WRANGLER
 2020 JEEP SAHARA WITH HYBRID
 E-TORQUE OPTION
 3.6L ENGINE
 Fits both 2 & 4-door models.

OVERVIEW:

1. Take a moment to read and understand these instructions before installing your Flowmaster performance system.

NOTE: Please inventory all parts now before continuing and if necessary, report any missing items to our tech line. This will avoid potentially stranding your vehicle until any missing replacement parts arrive.

ITM #	PART #	DESCRIPTION	QTY.
1	15192S	Resonator	1
2	86505S	Front Pipe	1
3	86506S	Over-axle Pipe	1
4	842583-511	Muffler	1
N/A	PK964	Hardware Package includes:	1
5	MC250BS	2½" Stainless Band Clamp	3
6	HW502	7/16" Hanger Keeper	3

PREPARE VEHICLE FOR KIT INSTALLATION:

2. Raise vehicle up on a hoist or rack to working height. If you don't have access to a hoist or rack, support vehicle with jack stands.

WARNING:
 Avoid serious burns! Allow your vehicle time to cool completely before touching any factory engine components.

To ease preparation and installation of your new kit:

- Apply penetrating lubricant to mounts, bolts and clamps before you remove them.
- Use stands as necessary to support parts as you detach them from your vehicle and again as you install new parts.

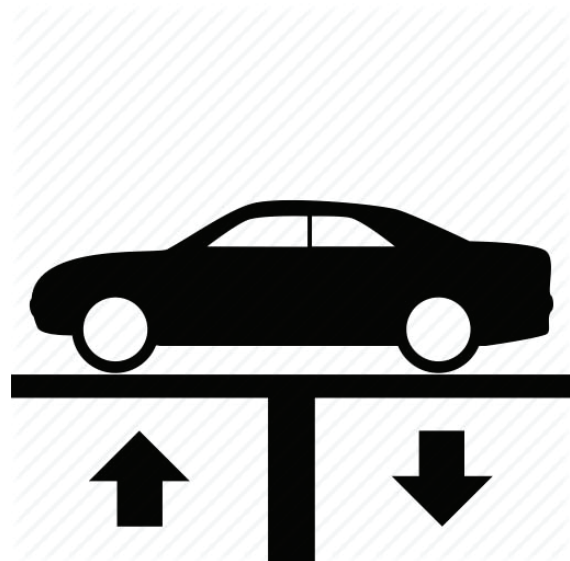

3. Remove bolts (x4) securing muffler mounts on driver and passenger side. Retain for re-use.



4. Loosen clamp at muffler inlet connection above rear axle then remove muffler from vehicle.



5. Place stock muffler next to **muffler (4)** oriented in the same direction. Then transfer driver and passenger side mounts over.

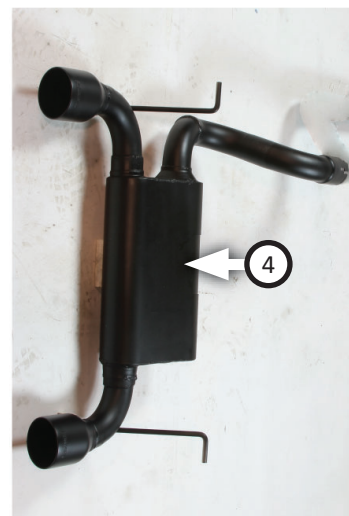

6. Remove wire hanger on resonator assembly from isolator, and loosen bolt on clamp at resonator inlet.

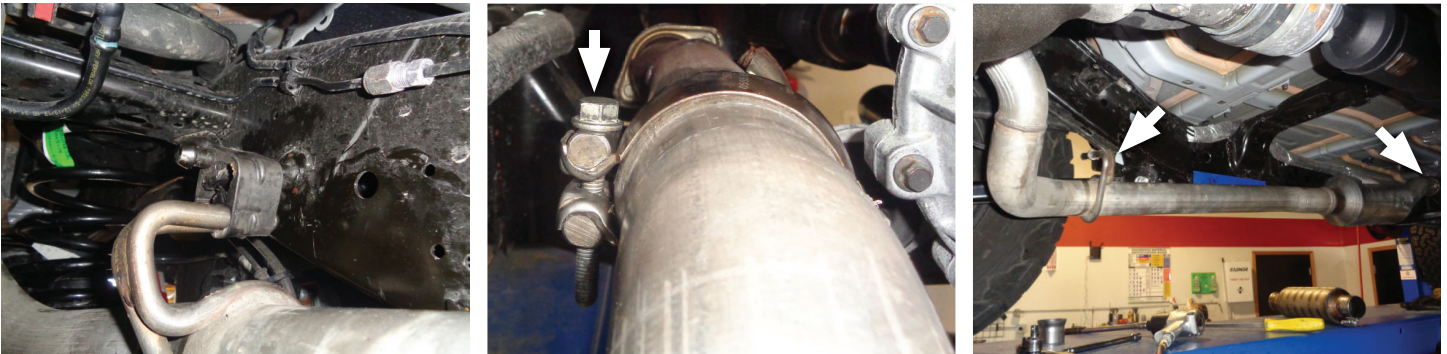

7. Remove resonator assembly from vehicle and retain clamp for re-use.



INSTALL FLOWMASTER EXHAUST SYSTEM:

8. Remove nuts from stock and Flowmaster clamps, apply anti-seize compound to bolts and re-install nuts.

NOTE: The image in this step is intended for illustrative purposes only and may or may not accurately reflect components included in your kit.



9. For **TWO-DOOR VEHICLES ONLY**, cut 2½" off the rear end of **front pipe (2)**.

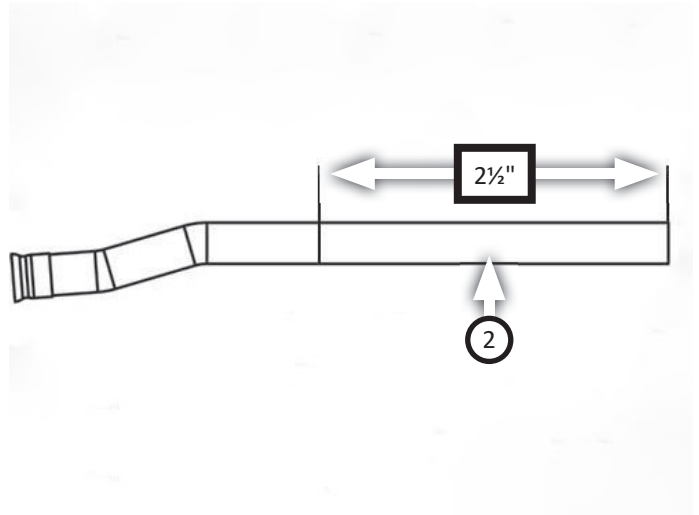

10. Place factory clamp (removed step 8) over outlet of factory pipe, connect **resonator (1)** to factory pipe, then tighten clamp enough to allow for adjustment.



11. Place **clamp (5)** onto resonator then connect front pipe to it. Make sure front pipe bend is oriented upwards, then tighten clamp just enough to allow for adjustment.

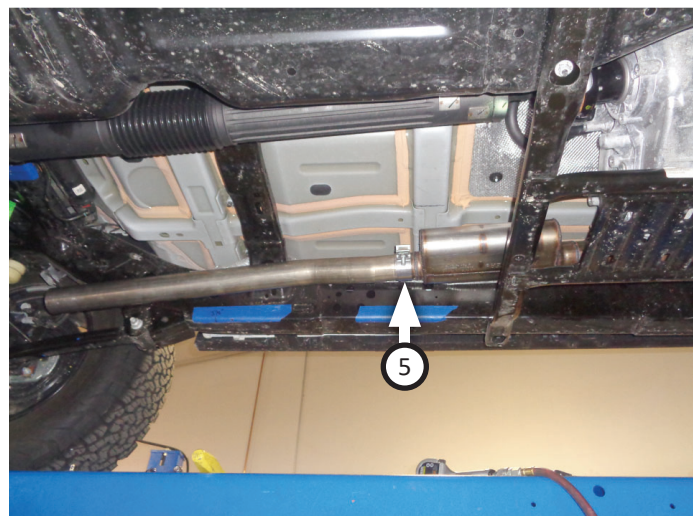

12. Place **clamp (5)** onto **over-axle pipe (3)** then connect it to front pipe while pushing wire hanger into rubber isolator on vehicle. Tighten clamp just enough to allow for adjustment.

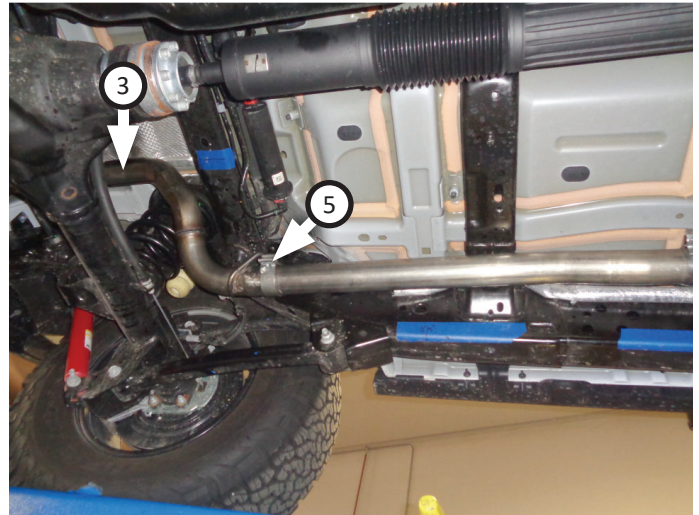

13. Place **clamp (5)** onto inlet of muffler. Connect muffler to over-axle pipe. Support muffler and ensure all connections are completely seated.
14. Place muffler hanger mounts into position, then reinstall and tighten factory bolts. (removed step 3).
15. Adjust exhaust components for fit; maintaining $\frac{1}{2}$ " clearance and compensating for suspension, travel and vibration then tighten all clamps.
16. Secure exhaust system by fitting (x3) **hanger keepers (6)** onto each wire hanger that runs perpendicular to your vehicles axle.
17. Recommended: Secure slip-fit connections with a 1-inch tack weld then spray high-temp paint over each weld to prevent rust and premature corrosion.

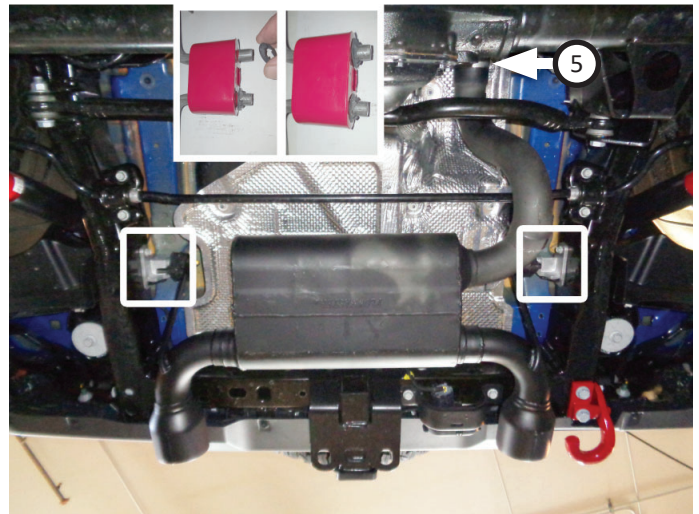

Congratulations, the installation of your FLOWMASTER performance exhaust system is now complete!





Installation Diagram
817819
2018-21 JEEP WRANGLER
2020 JEEP SAHARA WITH HYBRID
E-TORQUE OPTION
3.6L ENGINE
Fits both 2 & 4-door models.

