



Installation Instructions
817891
2019-21 GM SILVERADO/SIERRA 1500
6.2L ENGINE
2/4 Wheel Drive & All Wheelbases
 Crew Cab & Double Cab

OVERVIEW:

1. Take a moment to read and understand these instructions before installing your Flowmaster performance system.

NOTE: Please inventory all parts now before continuing and if necessary, report any missing items to our tech line. This will avoid potentially stranding your vehicle until any missing replacement parts arrive.

ITM #	PART #	DESCRIPTION	QTY.
1	36066S	Inlet Pipe	1
2	36065S	Extension Pipe	1
3	8535562-Z	American Thunder Muffler	1
4	86559S	Right Front Tailpipe	1
5	86560S	Left Front Tailpipe	1
6	86561S	Right Rear Tailpipe	1
7	86562S	Left Rear Tailpipe	1
N/A	PK986	Hardware Package includes:	1
8	MC350BS	3½" Stainless Band Clamp	2
9	MC250BS	2½" Stainless Band Clamp	4
10	HW503	1/2" Hanger Keeper	3

REMOVE STOCK EXHAUST SYSTEM:

2. Raise vehicle up on a hoist or rack to working height. If you don't have access to a hoist or rack, support vehicle with jack stands.

WARNING:
 Avoid serious burns! Allow your vehicle time to cool completely before touching any factory engine components.

To ease preparation and installation of your new kit:

- Apply penetrating lubricant to mounts, bolts and clamps before you remove them.
- Use stands as necessary to support parts as you detach them from your vehicle and again as you install new parts.

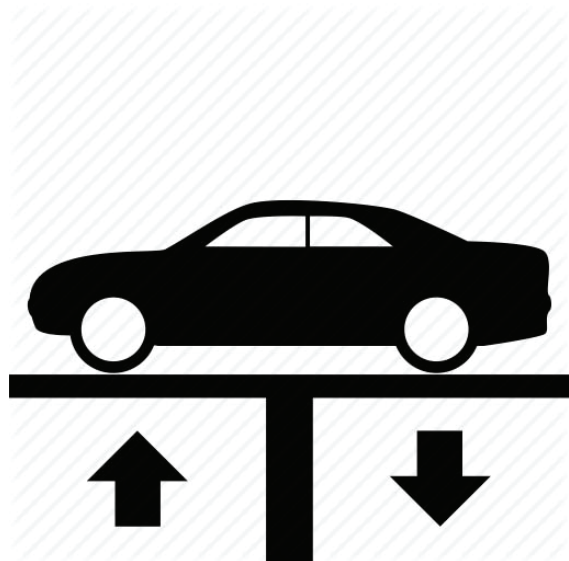

NOTE: Follow steps 3-4 only if your vehicle includes a back-up sensor option. Otherwise, proceed to step 5.

3. For ease of access, remove screws (x4) through driver and passenger side back-up sensor brackets (located inside corners of rear bumper). Retain them for later.

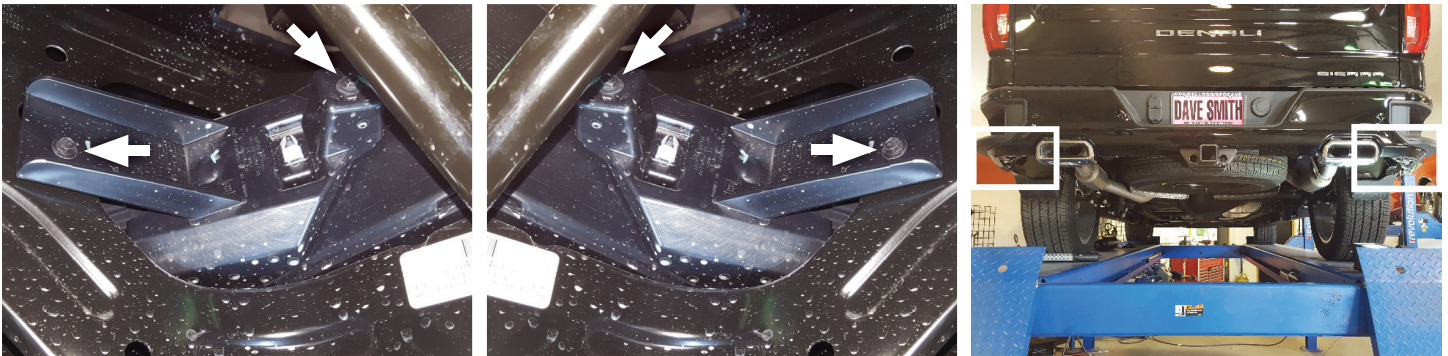

4. Unplug passenger and driver side sensor wiring then remove brackets from vehicle. Retain them for later use.

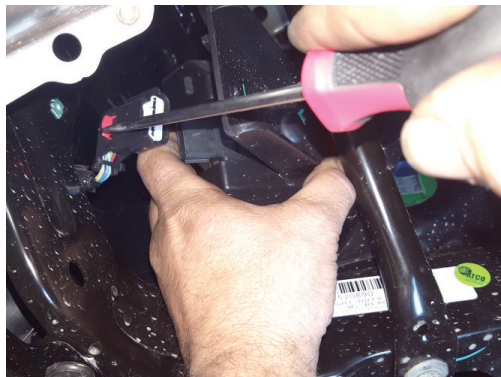

5. Remove screws (x3) securing passenger side bezel. Complete this step for the driver side as well.

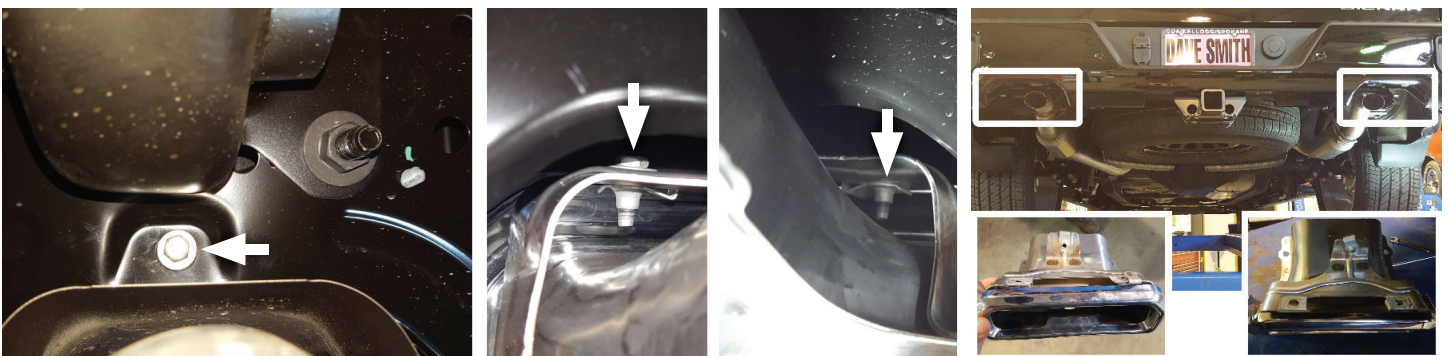

6. Remove nuts (x2) from driver side tailpipe flange. Then remove isolator and bolt from frame and disassemble tailpipe from vehicle. Retain isolator and bolt for later use.



7. Remove passenger side tailpipe isolater from frame. Then cut remaining tailpipe assembly just behind muffler exit.



8. Disassemble tailpipe wire hangers from rear isolators then remove remaining tailpipe from vehicle. Retain isolater and bolt for later use.



9. Disassemble inlet pipe wire hanger from isolater.
Loosen factory clamp at catalytic converter and remove remaining muffler assembly from vehicle.

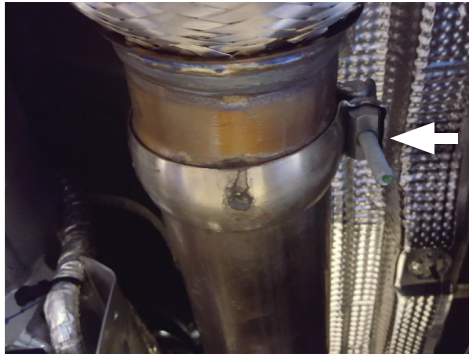
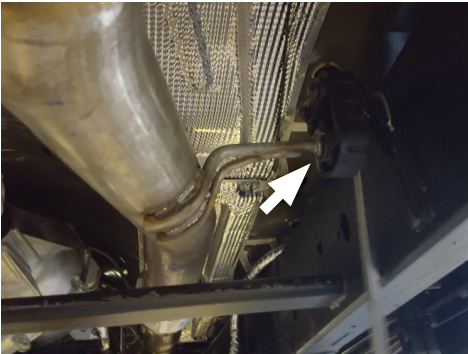

10. Release tab and remove clamp from muffler assembly.
Retain for later use.



11. Remove nuts from stock and Flowmaster clamps, apply anti-seize compound to bolts and re-install nuts.

NOTE: The image in this step is intended for illustrative purposes only and may or may not accurately reflect components included in your kit.



INSTALL FLOWMASTER EXHAUST SYSTEM

12. Place clamp (removed step 10) onto **inlet pipe (1)**. Connect inlet pipe to catalytic converter, mount wire hanger into factory isolator then tighten clamp just enough to allow for adjustment.

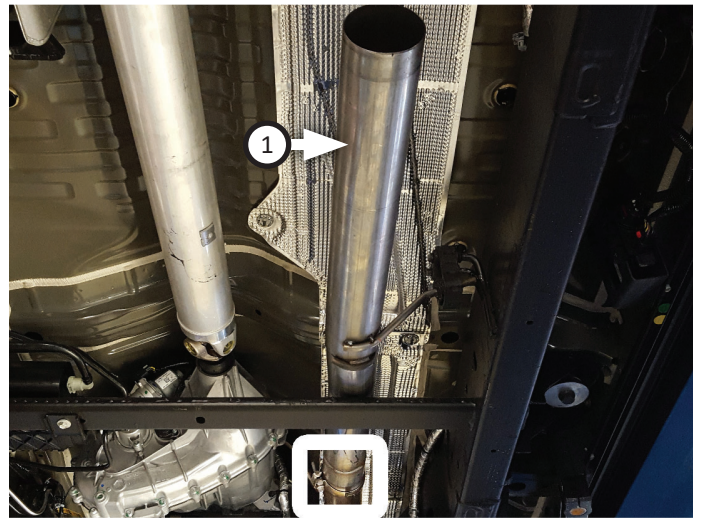
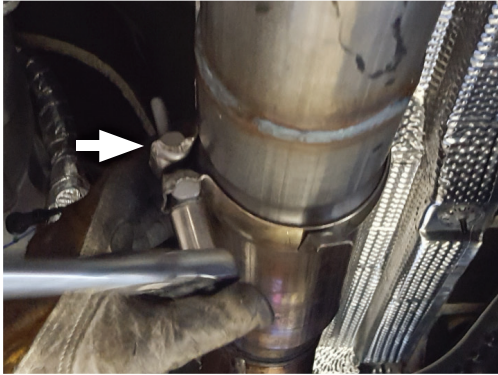

NOTE: Complete step ONLY for Crew Cab - 6'5" bed models.

13. Place **clamp (8)** onto **extension pipe (2)** inlet then connect extension to inlet pipe.

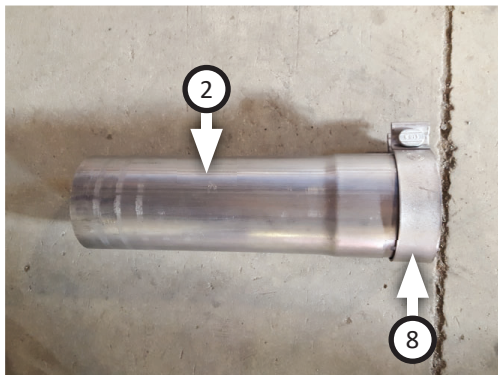

14. Place **clamp (8)** onto **muffler (3)** inlet. Place (x2) **clamps (9)** onto muffler outlets. Connect muffler to inlet or extension pipe then tighten front clamp just enough to allow for adjustment.

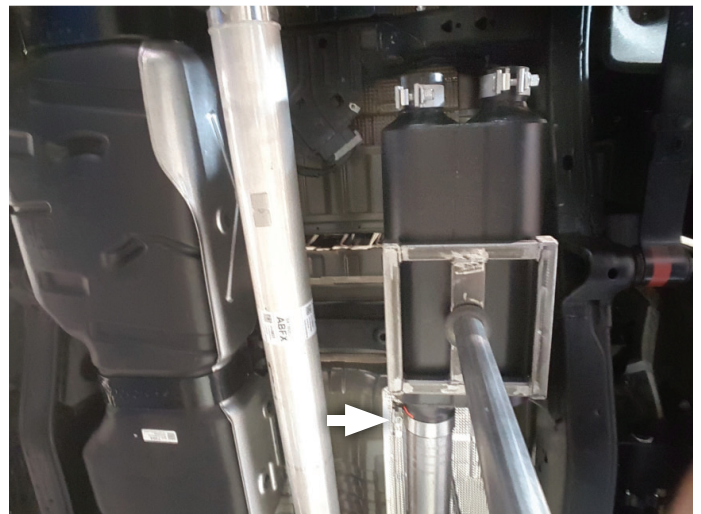
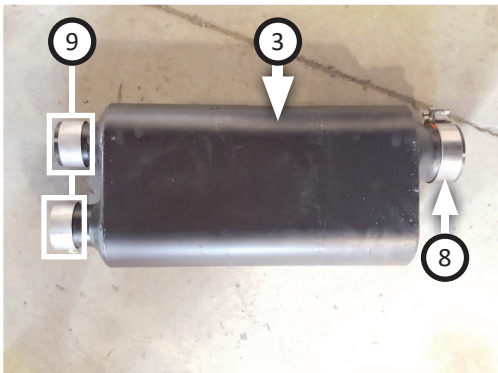

15. Route **right (4)** and **left (5)** front tailpipes over axle and connect them to muffler outlets. Mount wire hangers in isolators then tighten clamps (x2) enough to hold parts.

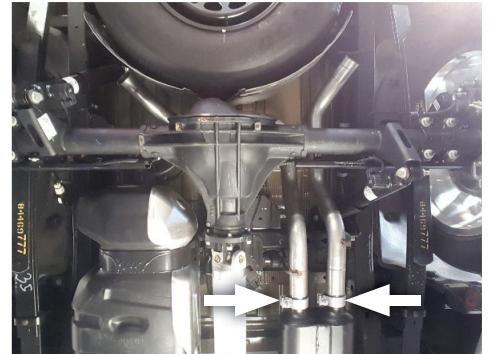
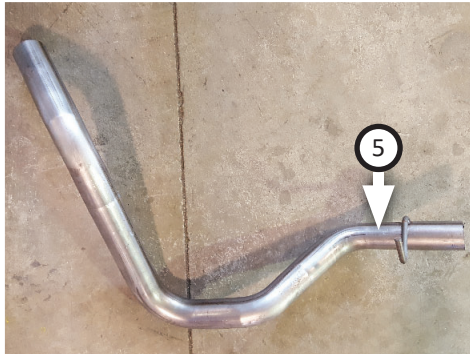
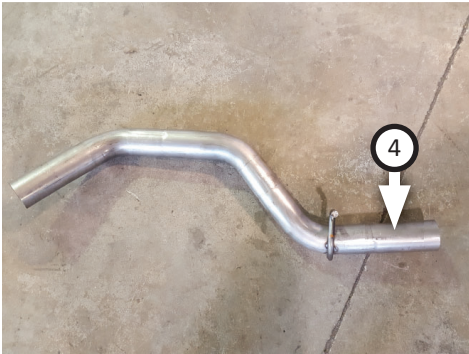

16. Place **clamp (9)** and isolator (removed step 6) onto **left rear tailpipe (7)** then connect it to left front tailpipe. Fasten isolator with bolt then tighten clamp enough to allow for adjustment.



17. Place **clamp (9)** and isolator (removed step 8) onto **right rear tailpipe (6)** then connect it to right front tailpipe. Fasten isolator with bolt then tighten clamp enough to allow for adjustment.



18. For applicable vehicles, re-install back up sensor brackets and screws (removed steps 3-4) then plug in sensor wiring.
19. Adjust exhaust components to provide a satisfactory fit. Maintain a minimum of ½" clearance around all components of the exhaust system, keeping in mind suspension, travel and vibration. After making any required adjustments, securely tighten all clamps.

NOTE: If your exhaust system still needs alignment, adjust isolator mounts in step 16 and 17.

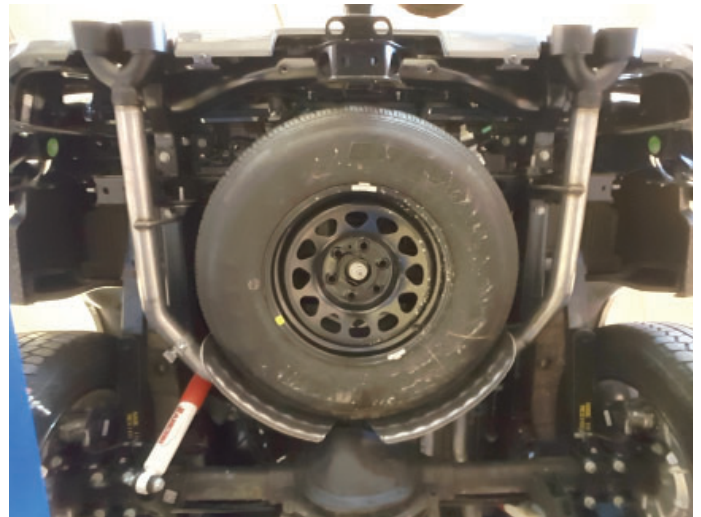

20. Secure exhaust system by fitting (x5) **hanger keepers (10)** onto each wire hanger that runs perpendicular to your vehicles axle.
21. We recommend applying a one inch tack weld to all slip-fit connections for a more secure installation. You may also apply high temperature paint over welded areas to prevent rust and premature corrosion.

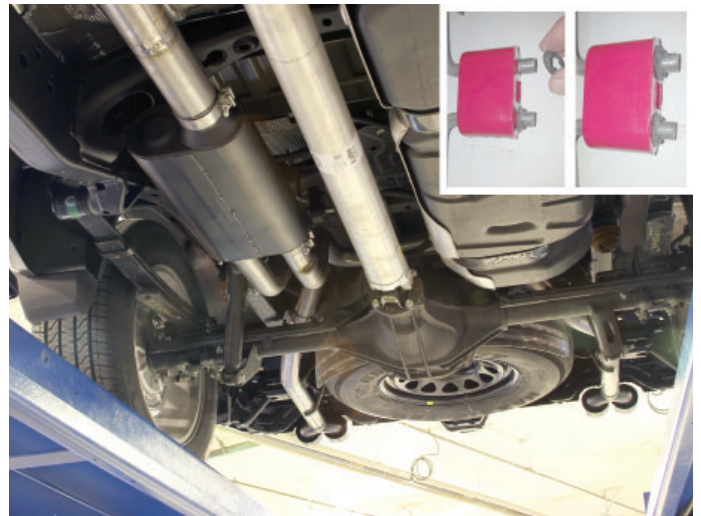

Congratulations, the installation of your FLOWMASTER performance exhaust system is now complete!





Installation Diagram
817891
2019-21 GM SILVERADO/SIERRA 1500
6.2L ENGINE
2/4 Wheel Drive & All Wheelbases
Crew Cab & Double Cab

