

LoadLifter 7500 XL™

ULTIMATE



XL

ULTIMATE



Installation Guide

Kit 57589

RAM Heavy Duty



Representative vehicle image

For maximum effectiveness and safety, please read these instructions completely before proceeding with installation.

Failure to read these instructions can result in an incorrect installation.

TABLE OF CONTENTS

Installation Diagram	2
Hardware and Tools Lists	3
Introduction	4
Notation Explanation	4
Installing the LoadLifter 7500 XL Ultimate System	5
Getting Started	5
Building the Air Spring Assemblies	7
Attaching the Assemblies to the Frame	9
Installing the Air Lines	11
Maintenance and Use Guidelines	12
Minimum and Maximum Recommended Pressure	12
Finished Installation Photos	12
Installation Checklist	13

Installation Diagram

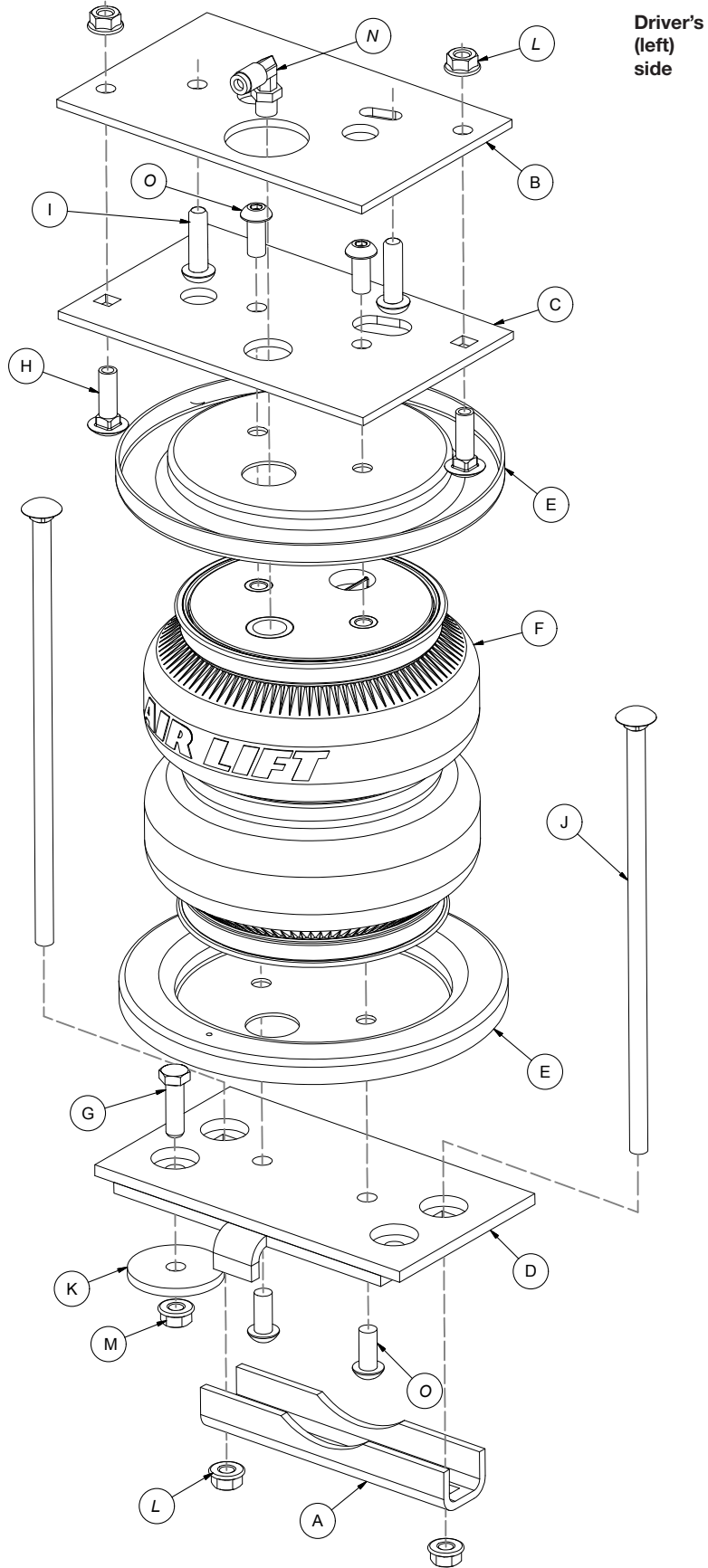

fig. 1

Hardware and Tools Lists

HARDWARE LIST

Item	Part #	Description.....	Qty
A	01531	Clamp bar.....	2
B	07160	Upper frame bracket	2
C	07161	Upper air spring bracket	2
D	03038	Lower bracket	2
E	11897	Roll plate	4
F	58120	Air spring	2
G	17188	3/8"-16 x 1 1/4" Hex-head cap screw	2
H	17361	3/8"-16 x 1 1/4" Carriage bolt.....	4
I	17366	M10-1.50 x 35 Button-head cap screw	4
J	17387	3/8"-16 x 10" Carriage bolt	4
K	18260	Large flat washer.....	2
L	18422	3/8"-16 Serrated flange lock nut.....	8
M	18435	3/8"-16 Nylon lock nut	2
N	21837	Push-to-connect (PTC) swivel fitting.....	2
O	17527	3/8"-24 x 3/4" Button-head cap screw	8
AA	20086*	Air line.....	1
BB	10466*	Zip tie	6
CC	18411*	5/16" Lock washer	2
DD	21230*	Valve cap	2
EE	21233*	5/16"-32 Hex nut.....	4
FF	21234*	Rubber washer	2
GG	18501*	Flat washer	2

* not pictured in the Installation Diagram

TOOLS LIST

Description.....	Qty
Standard and metric open-end or box wrenches	Set
Ratchet	1
Standard and metric, regular and deep-well sockets	Set
5/16" Drill bit (very sharp).....	1
9/16" Crows foot adapter (Fig. 2).....	1
Heavy-duty drill	1
Torque wrench.....	1
Standard and metric socket hex-key wrenches.....	Set
Hose cutter, razor blade or sharp knife	1
Hoist or floor jacks	1
Safety stands.....	2
Safety glasses	1
Air compressor or compressed air source	1
Spray bottle with dish soap/water solution.....	1

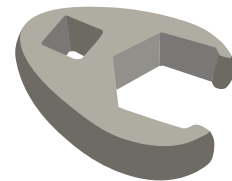

Crows foot adapter

fig. 2

Introduction

The purpose of this publication is to assist with the installation, maintenance and troubleshooting of the LoadLifter 7500 XL Ultimate air spring kit. LoadLifter 7500 XL Ultimate utilizes sturdy, reinforced, commercial-grade double-convolute bellows. The bellows are manufactured like a tire with layers of rubber and cords that control growth. LoadLifter 7500 XL Ultimate kits are recommended for most 3/4- and 1-ton pickups and SUVs with leaf springs and provide up to 7,500 pounds of load-leveling support with air adjustability from 5-100 PSI.

It is important to read and understand the entire installation guide before beginning

NOTATION EXPLANATION

Hazard notations appear in various locations in this publication. Information which is highlighted by one of these notations must be observed to help minimize risk of personal injury or possible improper installation which may render the vehicle unsafe. The following definitions explain the use of these notations as they appear throughout this guide.

 **DANGER**

INDICATES IMMEDIATE HAZARDS WHICH WILL RESULT IN SEVERE PERSONAL INJURY OR DEATH.

 **WARNING**

INDICATES HAZARDS OR UNSAFE PRACTICES WHICH COULD RESULT IN SEVERE PERSONAL INJURY OR DEATH.

 **CAUTION**

INDICATES HAZARDS OR UNSAFE PRACTICES WHICH COULD RESULT IN DAMAGE TO THE MACHINE OR MINOR PERSONAL INJURY.

Installing the LoadLifter 7500 XL Ultimate System

GETTING STARTED

1. Raise the vehicle, support the frame with safety stands and remove the wheels. Drop the axle to make room for the air spring assemblies to be put into position between the frame and axle (Fig. 3).

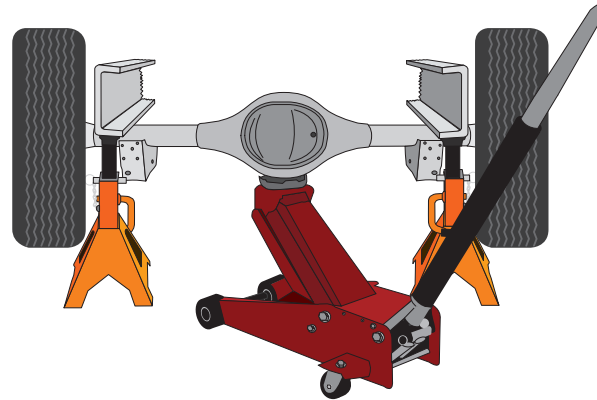

fig. 3

2. On the driver's (left) side by the axle on some models, there is a small vent tube (Fig. 4) that needs to be tied on an angle with a zip tie (BB).

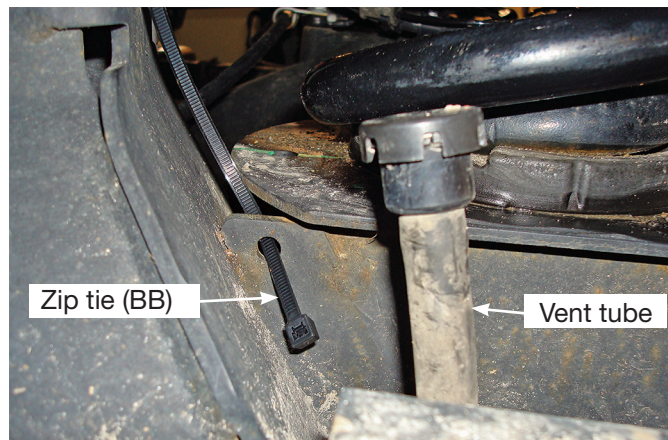

fig. 4

3. Insert the zip tie into the small hole in the lower coil spring seat, then around the vent tube and snug the zip tie enough to angle the tube out of the way (Fig. 5).

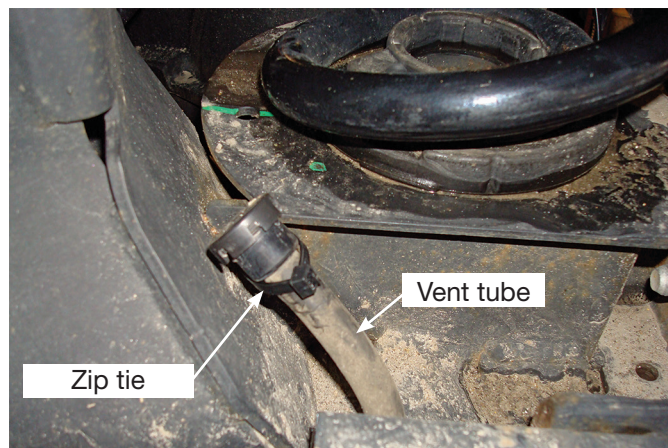

fig. 5

- Remove the jounce bumpers from both sides (Figs. 6 & 7).

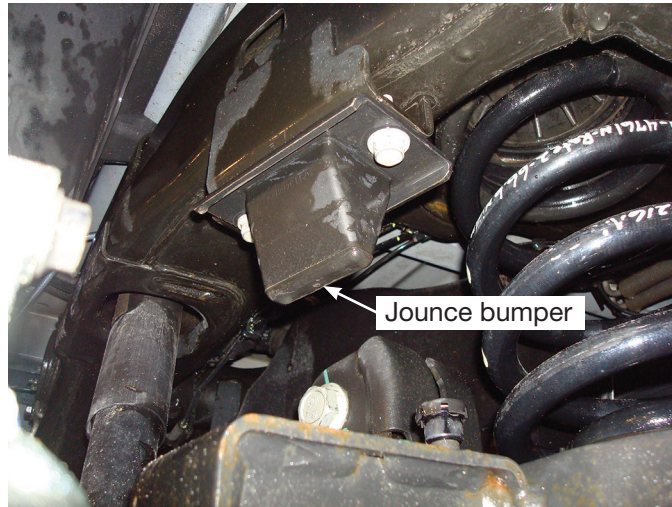

fig. 6

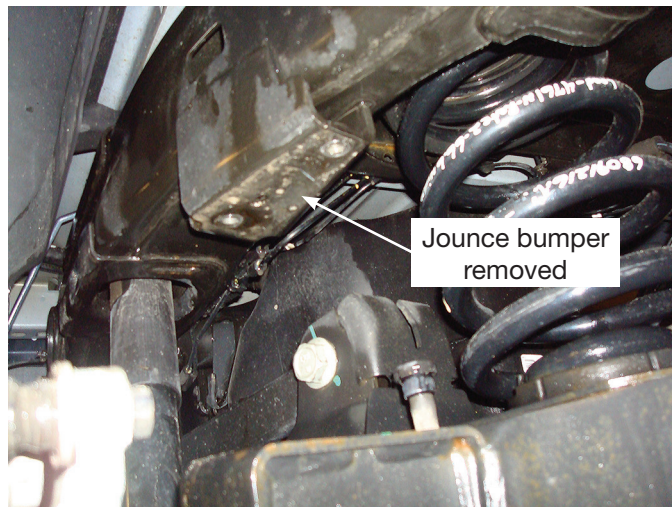

fig. 7

- Attach the upper frame bracket (B) to the frame (Figs. 8 & 9) using the M10-1.50 x 35 button-head cap screws (I). Torque the mounting hardware to 30 lb.-ft. (41Nm).

NOTE

The large hole in the bracket goes to the outside of the frame (toward the tire).

Driver's (left) side

fig. 8

Passenger's (right) side

fig. 9

BUILDING THE AIR SPRING ASSEMBLIES

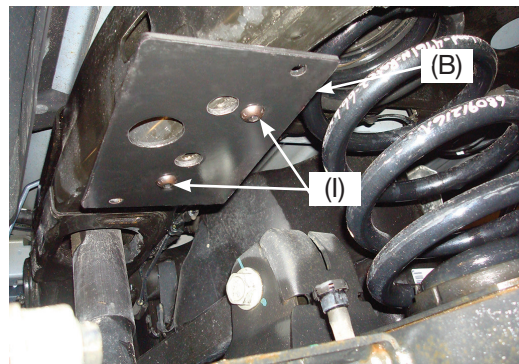
1. Set a roll plate (E) over the top of each air spring (F) (Fig. 10).

NOTE

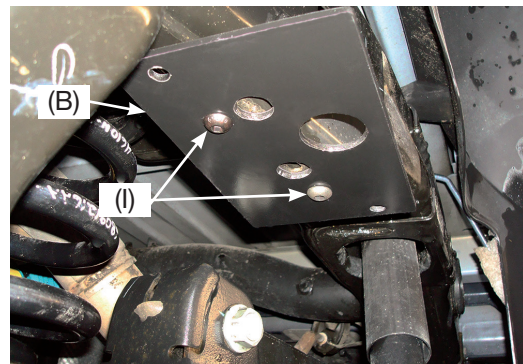
The radiused (rounded) edge of the roll plate (E) will be toward the air spring so that the air spring is seated inside both roll plates.

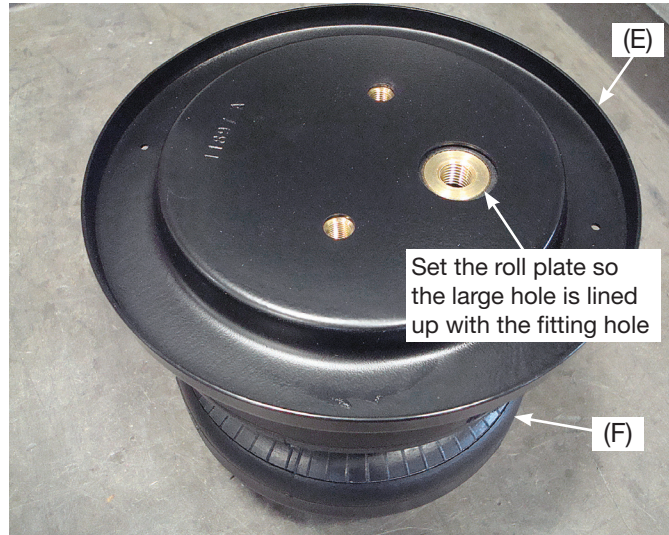

fig. 10

2. Set both air springs in front of you with the fitting inserts pointing toward you (Fig. 11).
3. Insert the 3/8"-16 x 1 1/4" carriage bolt (H) through the upper air spring bracket (C) in the square hole on both ends (Figs. 1 & 11).

NOTE

The upper air spring brackets will be mirror images when set onto the air springs (see Fig. 11).

Driver's (left) side assembly

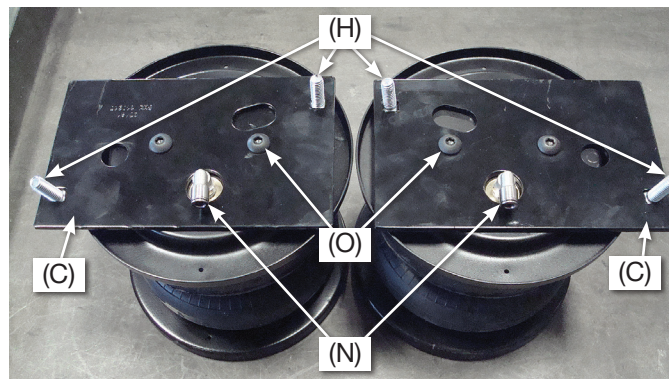

Passenger's (right) side assembly

fig. 11

4. Set both brackets onto the air springs and attach using the 3/8"-24 x 3/4" button-head cap screws (O) (Fig. 11). Torque to no more than 20 lb.-ft. (27Nm).
5. Install the swivel fitting (N) into the top of the air spring assemblies finger-tight plus 1 1/2 turns (Fig. 11). Repeat for both air springs.

6. Install the thick 3/8" large flat washer (K) onto the lower bracket (D) with 3/8"-16 x 1 1/4" hex-head cap screw (G) and 3/8"-16 nylon lock nut (M). Install the washer on the same side as the flanges (Figs. 1 & 12). Torque to 31 lb.-ft. (42Nm).

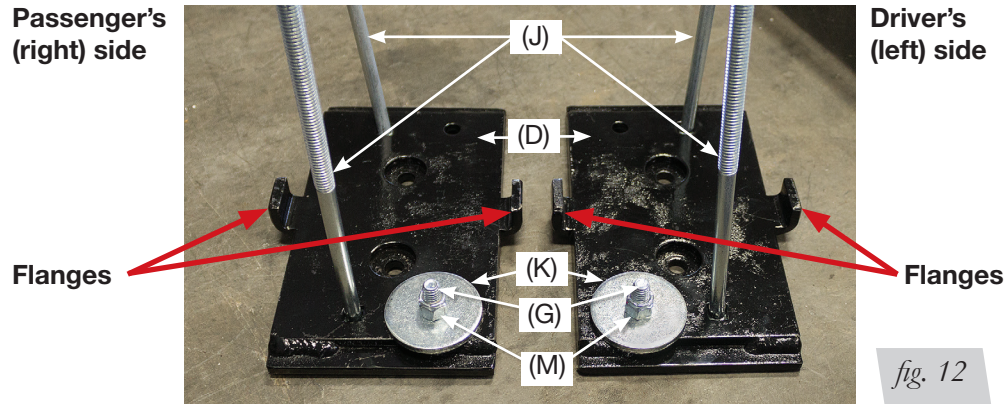

7. Insert the long 3/8"-16 x 10" carriage bolts (J) into the square holes in the lower bracket from the opposite sides of the flanges (Figs. 1 & 12).
8. Set the roll plate (E) over the bottom of the air springs and install the lower brackets onto the air spring assemblies so the large washers previously installed are on the same side as the air fittings (Figs. 1 & 13).

**Passenger's
(right) side
assembly**

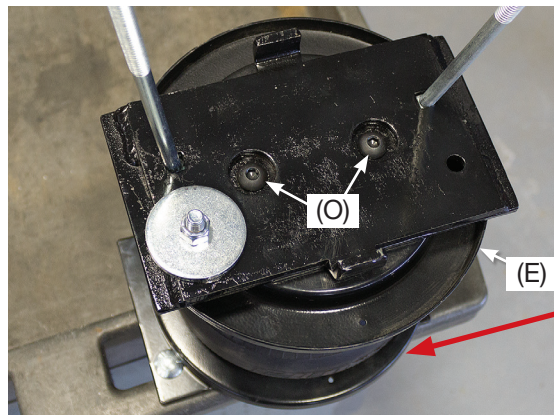

The large washer needs to be positioned on the lower bracket so that it is on the same side of the assembly as the air fittings.

9. Once oriented correctly, attach the lower brackets to the assemblies using the 3/8"-24 x 3/4" button-head cap screws (O) (Fig. 13) and torque the hardware to no more than 20 lb.-ft. (27Nm).

10. Figure 14 shows the finished assemblies.

**Passenger's
(right) side
assembly**



**Driver's
(left) side
assembly**

ATTACHING THE ASSEMBLIES TO THE FRAME

1. With the axle slightly hanging and the wheels removed, set the driver's (left) side assembly on the axle, making sure that the carriage bolt (J) goes in between the brake line and the axle, on the inboard side of the brake line bracket (Fig. 15). Repeat for the opposite side.

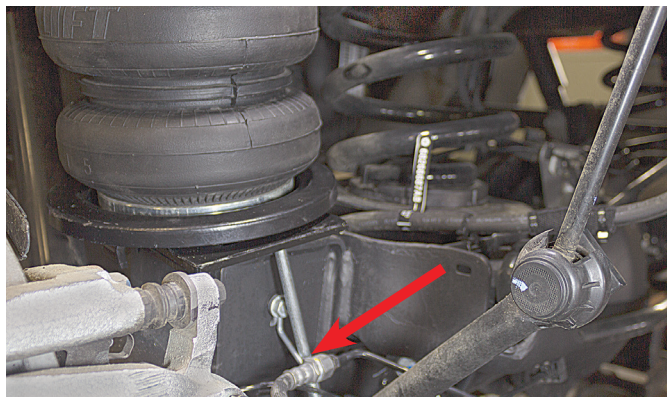

Carriage bolt must be in between the brake line and axle, on the inside of the brake line bracket on both driver's and passenger's air springs.

fig. 15

2. Carefully position the upper air spring brackets, making sure that the carriage bolts and fittings line up with the holes in the frame brackets (Fig. 16). If necessary, raise the axle so that the brackets come together, making sure the fittings and the carriage bolts go through the holes and do not bind.

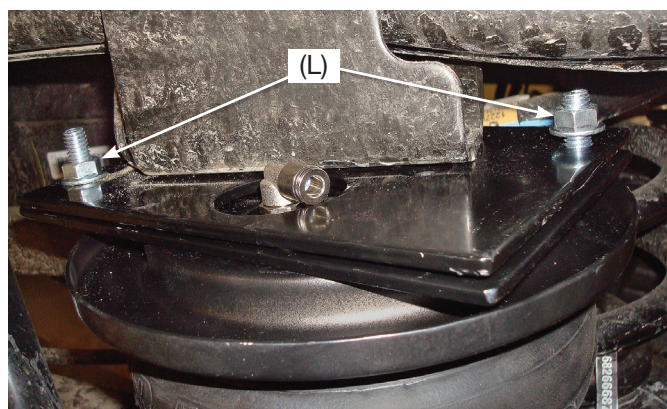

fig. 16

3. Install the 3/8"-16 serrated flange lock nuts (L) onto the upper carriage bolts and torque to 16 lb.-ft. (22Nm) (Fig. 16).

NOTE

It may be necessary to use a 9/16" crows foot adapter (Fig. 2) to torque the nut underneath the frame.

4. Raise the axle all the way and position the lower bracket over the lower jounce bumper strike plate. The large washer on the bottom of the bracket should be positioned forward of the lower jounce bumper strike plate (Fig. 17).

**Driver's
(left) side
assembly**



fig. 17

- Set the clamp bar (A) over the two long carriage bolts under the axle and fasten with 3/8"-16 serrated flange lock nuts (L) (Fig. 18). Torque the hardware evenly to 10 lb.-ft. (14Nm) (Fig. 19).

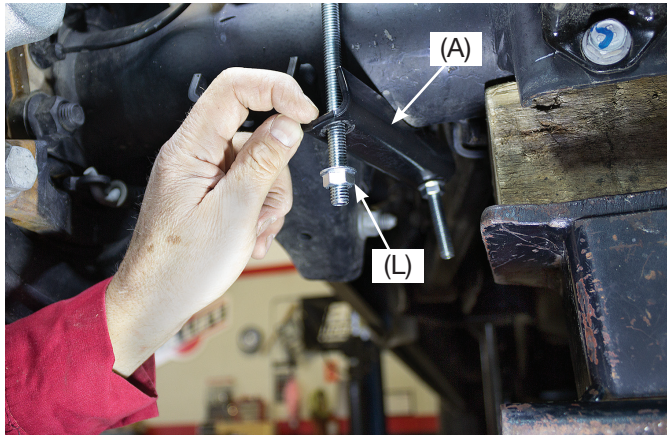
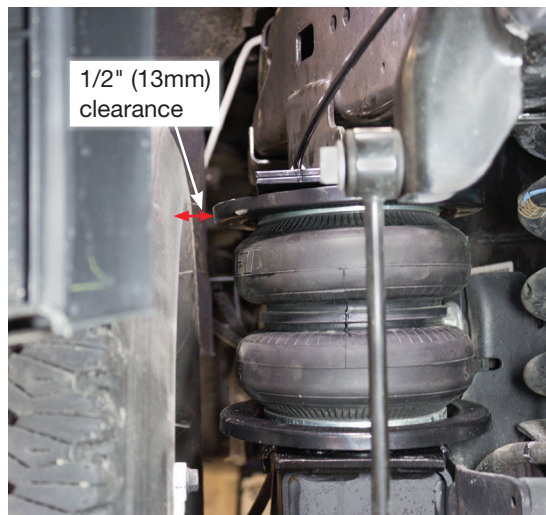

fig. 18

fig. 19

- Install the wheels and torque lug nuts to factory specifications. Remove the safety stands.

CAUTION

AFTER INSTALLING THE TIRES, IT WILL BE NECESSARY TO CHECK THE TIRE CLEARANCE. THERE MUST BE MORE THAN 1/2" (13MM) CLEARANCE BETWEEN THE TIRE AND THE UPPER ROLL PLATE ON THE AIR SPRING ASSEMBLY (FIG. 20). CHECK CLEARANCES IF CHANGING TIRE SIZES ON THE VEHICLES.

fig. 20

Installing the Air Lines

Choose the locations for the Schrader valves and drill a 5/16" (8mm) hole, if necessary (Fig. 21).

1. Cut the air line in half. Make clean, square cuts with a razor blade or hose cutter (Fig. 22). Do not use scissors or wire cutters.

CAUTION

KEEP AT LEAST 6" (152MM) OF CLEARANCE BETWEEN ALL AIR LINES AND THE EXHAUST SYSTEM. AVOID SHARP BENDS AND EDGES.

2. Use zip ties to secure the air line to fixed points along the chassis. Do not pinch or kink the air line. Leave at least 2" (51mm) of slack in the air line to allow for any movement that might pull on the air line. The minimum bend radius for the air line is 1" (25mm).
3. Install the Schrader valve in the chosen location (Fig. 23).

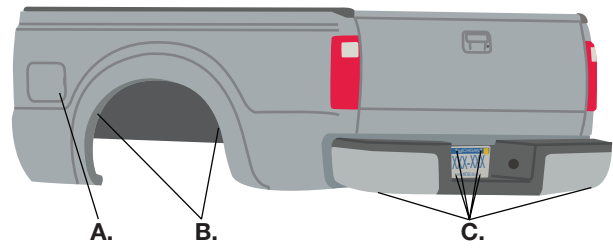

A. Inside fuel tank filler door
 B. Inside rear wheel wells
 C. License plate or rear bumper area

fig. 21

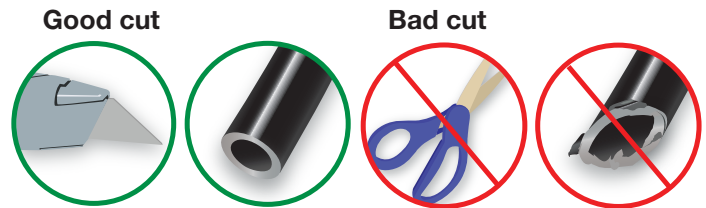

fig. 22

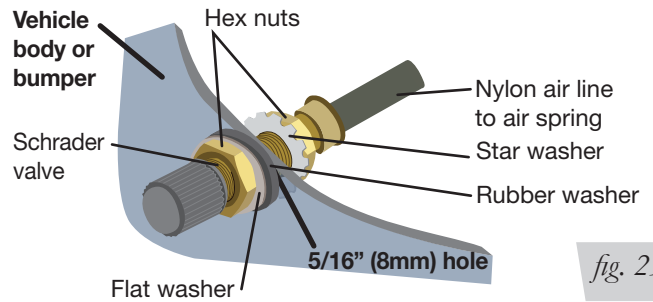

fig. 23

Maintenance and Use Guidelines

1. Check air pressure weekly.
2. Always maintain normal ride height. Never inflate beyond 100 PSI (7BAR).
3. If the system develops an air leak, use a soapy water solution to check all air line connections and the inflation valve core before deflating and removing the air spring.

Minimum Recommended Pressure	Maximum Air Pressure
5 PSI (.34BAR)	100 PSI (7BAR)

⚠ CAUTION

FOR SAFETY AND TO PREVENT POSSIBLE DAMAGE TO THE VEHICLE, DO NOT EXCEED MAXIMUM GROSS VEHICLE WEIGHT RATING (GVWR) OR PAYLOAD RATING, AS INDICATED BY THE VEHICLE MANUFACTURER.

⚠ CAUTION

ALTHOUGH THE AIR SPRINGS ARE RATED AT A MAXIMUM INFLATION PRESSURE OF 100 PSI (7BAR), THE AIR PRESSURE ACTUALLY NEEDED IS DEPENDENT ON LOAD AND GROSS VEHICLE WEIGHT RATING.

Finished Installation Photos

1. The following images show the finished installation of both sides. (Figs. 24-27).



Driver's (left) side top view

fig. 24



Passenger's (right) front view

fig. 25



Driver's (left) side rear view

fig. 26

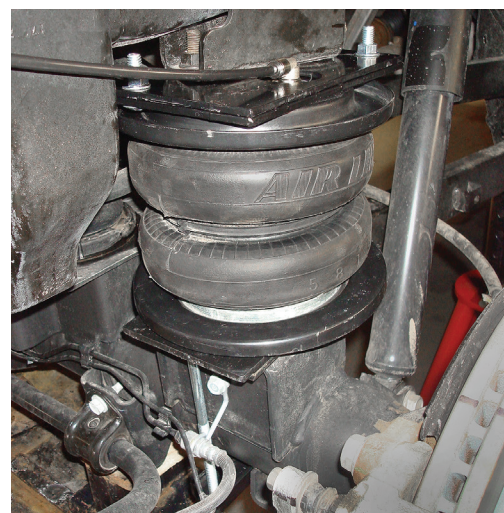

Passenger's (right) side view

fig. 27

INSTALLATION CHECKLIST

- Clearance test** — Inflate the air springs to 40-60 PSI (2.8-4.1BAR) and make sure there is at least 1/2" (13mm) clearance from anything that might rub against each air spring. Be sure to check the tire, brakes, frame, shock absorbers and brake cables.
- Leak test before road test** — Inflate the air springs to 40-60 PSI (2.8-4.1BAR) and check all connections for leaks. All leaks must be eliminated before the vehicle is road tested.
- Heat test** — Be sure there is sufficient clearance from heat sources, at least 6" (152mm) for air springs and air lines. If a heat shield was included in the kit, install it. If there is no heat shield, but one is required, call Air Lift customer service at **(800) 248-0892**.
- Fastener test** — Recheck all bolts for proper torque.
- Road test** — The vehicle should be road tested after the preceding tests. Inflate the air springs to recommended driving pressures. Drive the vehicle 10 miles (16km) and recheck for clearance, loose fasteners and air leaks.
- Operating instructions** — If professionally installed, the installer should review the operating instructions with the owner. Be sure to provide the owner with all of the paperwork that came with the kit.