



INSTALLATION MANUAL
PREMIUM REAR BUMPER
PRODUCT NUMBER: W4050 | W4051
APPLICATION: 2019 CHEVY 1500 | GMC 1500



IMPORTANT SAFETY GUIDE | Your safety and the safety of others is very important.

In order to help you make informed decisions about safety, we have provided the following warnings, safety precautions, installation instructions, and other important information to alert you to potential hazards that could hurt you or others.

Please do a job safety analysis before each task to identify potential hazards for your situation and remove/protect against them. Use own good judgment and take your time.

Check packaged materials immediately upon arrival to ensure that all listed parts are included and undamaged.

Read and understand all warnings, safety precautions, and instructions before installing this product.

SENSORS FIELD OF VIEW MAY BE ALTERED WITH USE OF THE REPLACEMENT BUMPER.

WARNINGS

- Failure to observe the following warnings and instructions provided in this manual could lead to severe injury and/or death.
- For professional installation only. Careless installation and/or operation can result in serious injury, death, and/or equipment damage. All liability for installation and use rests with the user or consumer.
- Fab Fours, Inc. only approves installing this product according to these written instructions with the hardware provided. Failure to install according to these instructions will invalidate the warranty. This includes, but is not limited to, using alternative installation methods, hardware, or materials.
- This product is for off road use only.

SAFETY PRECAUTIONS

- Always remove jewelry and wear eye protection.
- Always use extreme caution when jacking up a vehicle for work. Set emergency brake and use tire blocks. Locate and use the vehicle manufacturers designated lifting points. Use jack stands.
- Always use appropriate and adequate care in lifting components into place.
- Always ensure components will remain secure during installation and operation.
- Always wear safety glasses when installing this kit. A drilling operation will cause flying metal chips. Flying chips can cause serious eye injury.
- Always use extreme caution when drilling a vehicle. Always disconnect power before welding. Thoroughly inspect the area to be drilled (on both sides of material when possible) prior to drilling, and relocate any objects that may be damaged.
- Always use extreme caution when welding a vehicle. Thoroughly inspect the area to be welded (on both sides of material when possible) prior to welding, and relocate any objects that may be a fire hazard. When welding in a cab, make sure the interior surfaces are covered (e.g., welding blanket) and a fire extinguisher is at hand.
- Always use extreme caution when cutting and trimming during fitting.
- Always tighten all nuts and bolts securely per installation instructions.
- Always route electrical cables carefully. Avoid moving parts, components that become hot, and rough or sharp edges.
- Always insulate and protect all exposed wiring and electrical terminals.
- Perform regular inspections and maintenance on mounts and hardware.

TABLE OF CONTENTS

- 2 SAFETY / DISCLAIMER
- 3 TABLE OF CONTENTS
- 4 A MESSAGE FROM THE OWNER
- 5 GETTING STARTED
- 6 PROVIDED MATERIAL
- 7 DISASSEMBLY
- 10 INSTALLATION
- 15 CONTACT

A MESSAGE FROM THE OWNER



Fab Fours' was born out of a passion for customizing vehicles and a love of the outdoors. Our engineering team uses the latest 3D design software to turn new product ideas into reality. In our factory, designs come to life with the combination of cutting edge technology for metal cutting and forming and an American workforce that puts its' heart and pride into every product.

From design and manufacturing, to quality and delivery, Fab Fours' mission is to be the market leader for steel truck and jeep accessories. We make sure a quality product is delivered on time, more than expected, better than expected to our customers.

Enjoy your new Fab Fours product. Welcome to the family!

Ereg Higgs

FOUNDER, FAB FOURS

GETTING STARTED

Before you begin the installation process of your new Fab Fours product, we suggest laying out all materials and parts on a pad or protective surface.

Failure to fully account for all components before beginning installation may leave vehicle immobile until part is acquired. Refer to the next pages as an inventory check.

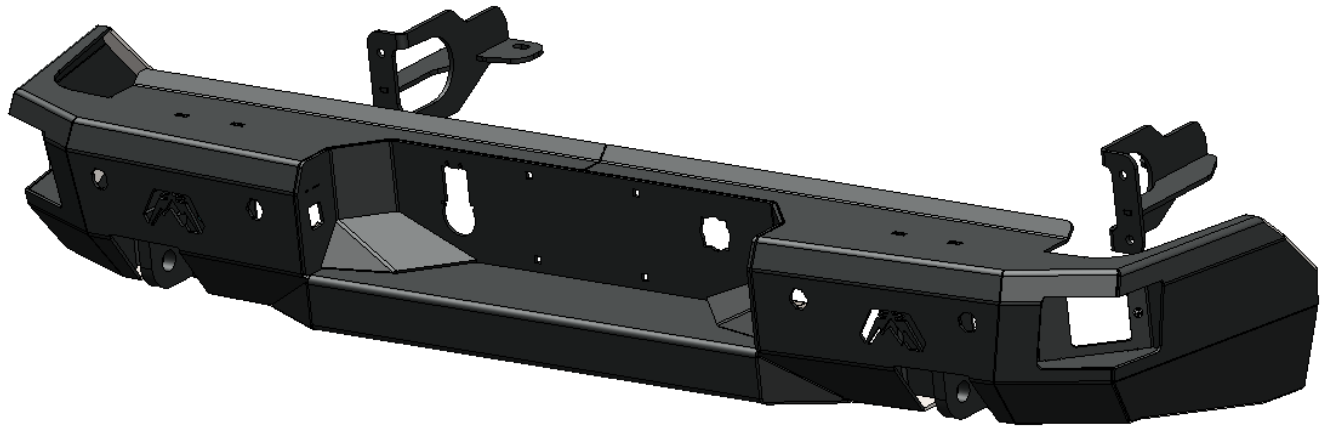

PROVIDED MATERIALS

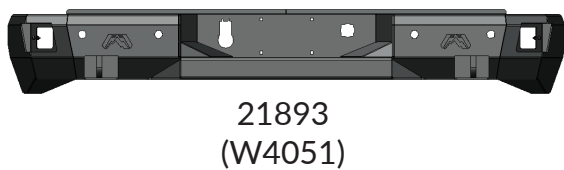
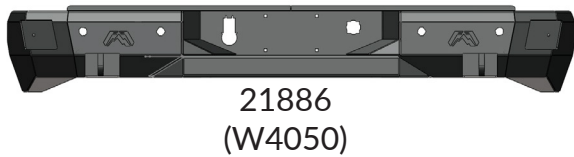
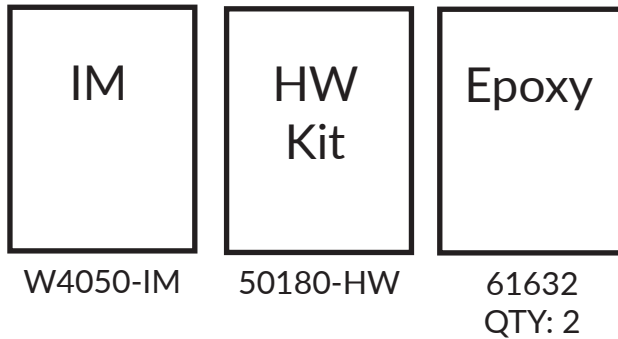

HARDWARE KIT | 50180

FAB FOURS IDENTIFICATION	COMPONENT DESCRIPTION	QTY
50180-HW	1/2" diameter nylon spacer, 3/8" long	2
50180-HW	#10-24 x 1 1/4", stainless steel, button head cap screw	2
50180-HW	#10, stainless steel, flat washer	4
50180-HW	10-24 Nyloc hex nut	2
50180-HW	7/16"-14 x 1.5", yellow zinc, hex head cap screw, grade 8	4
50180-HW	7/16", yellow zinc, flat washer, grade 8	8
50180-HW	7/16", yellow zinc, lock washer, grade 8	4
50180-HW	7/16"-14, yellow zinc, hex nut, grade 8	4
50180-HW	#8-32 x 3/4", stainless steel, button head cap screw	4
50180-HW	#8-32, yellow zinc, nyloc nut	4
50180-HW	#8, yellow zinc, flat washer	4

TOOLS REQUIRED

- 1/8" Allen key
- 3/32" Allen key
- 5/8" open end wrench
- 11/16" socket wrench
- 7mm socket wrench
- 13mm socket wrench
- 19mm socket wrench
- 21mm socket wrench
- Zip-ties
- Angle grinder
- Cutting wheel
- Drill
- 7/32" drill bit

ASSISTANCE

We recommend two people perform the installation as items are heavy and may need to be held in place while installing.

ORGANIZATION

Disassemble the vehicle where you can catalog and store everything. We suggest labeling and bagging all the OEM bolts when removing from the vehicle. Failure to keep track of parts could lead to an inability to properly reinstall components.

DISASSEMBLY

1. Remove license plate.
2. Disconnect trailer receptacle plug from the back of the bumper.
3. If equipped, unplug back-up/license plate lights from truck.
4. If equipped, remove sensors from behind license plate from bumper.
5. If equipped, remove blind spot sensors from side of rear bumper.
6. Using a 13mm wrench, remove the two (2) bolts attaching the stock bumper to the factory trailer hitch located behind the license plate. (Figure 1)

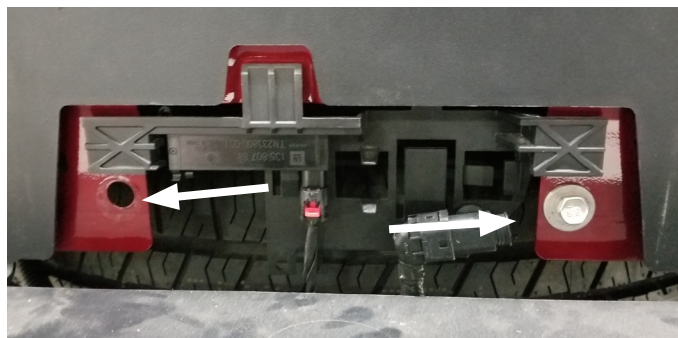

Figure 1

7. Using a 13mm socket wrench, remove the two (2) 13mm bolts attaching the side wings of the bumper to the bumper support rods. (Figure 2)



Figure 2

8. Using the 19mm socket wrench, remove the four (4) OEM nuts (two per side) attaching the stock bumper to the chassis. (Figure 3)

9. With assistance, remove the OEM bumper from the truck.

10. Using a 21mm socket wrench, remove the bumper support rods. (Figure 4)

11. Using a 21mm socket wrench, remove the two (2) bolts underneath each side of the hitch. (Figure 5)



Figure 3



Figure 4



Figure 5

12. Remove the OEM electrical harness from bumper by removing the ribbed shank push-in rivet. (Figure 6)

13. Remove the sensor from the sensor housing by expanding both sides of the sensor housing and lifting up. (Figure 7-8)



Figure 6



Figure 7



Figure 8

14. Remove the sensor housing from the bumper by depressing the four (4) tabs while pulling outward from the outside of the bumper. (Figure 9-10)

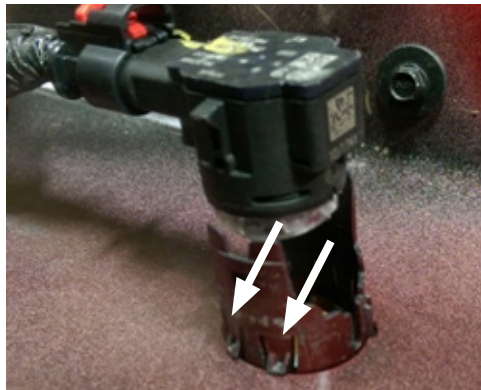

Figure 9

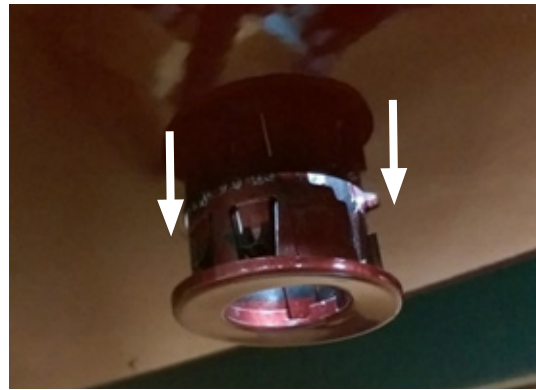

Figure 10

15. Remove spare tire access cover, license plate plastic inserts, and trailer plug from the OEM bumper.

16. Using a 7mm socket wrench, remove the tag lights. Remove the threaded clip nuts from the OEM bumper.

INSTALLATION

17. Using an angle grinder with a cutting wheel or similar tool, remove the bumper supports from the top of the receiver hitch. (Figure 11-12)

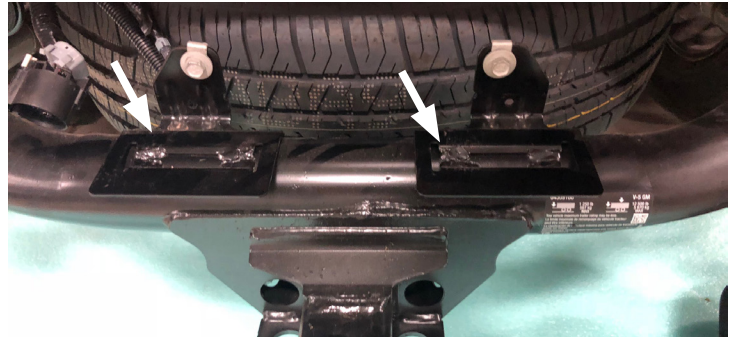

Figure 11

18. Run the wiring harness through the mounting boxes welded in the bumper.



Figure 12

19. FOR SENSOR BUMPER INSTALLATION ONLY: Install the sensor housings into the appropriate slots by inserting each housing from the outside of the bumper. (Figure 13)



Figure 13

20. Replace the sensors in the appropriate housings and zip-tie any loose harness to the bumper. (Figure 14)



Figure 14

21. Install the OEM threaded nut clip on to the bracket welded in the bumper and using the 7mm socket wrench, bolt the OEM tag light in place. (Figure 15)



Figure 15

22. Insert the trailer plug receptacle to the bumper and mark the bolt locations for drilling. (Figure 16)

23. Remove the trailer plug receptacle. Using a drill with a 7/32" drill bit, drill out the trailer plug receptacle .

24. Using a 7mm socket wrench and the 3/32" allen key, install the provided four (4) #8-32 button head cap screws, flat washers, and hex nuts, install the trailer plug to the bumper. (50180-HW)

25. Reinstall the license plate with provided plastic inserts. (50180-HW)

26. Reinstall the OEM spare tire access by pushing the OEM piece into bumper.

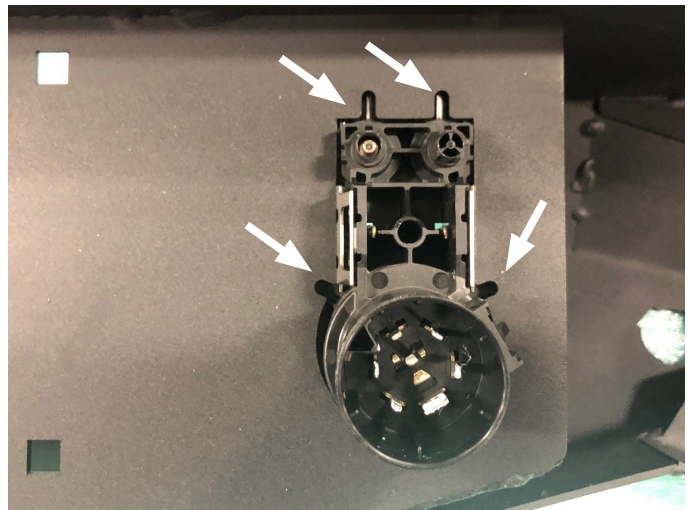

Figure 16

NOTE: If installing the W4050, skip to step 31 of this section and continue installation.

27. If equipped, slide blind spot monitor into tab on the back of the step pocket. (Figure 17)



Figure 17

28. Insert one (1) #10-24 18-8 Stainless Steel Button Head Cap Screw with one (1) #10 Flat washer through the hole in the side pocket. As you push the bolt through, install the provided nylon spacer between the bumper and the blind spot monitor. Install one (1) #10 flat washer and finger-tighten the #10-24 nylock nut. (50180-HW) (Figure 18-19)



Figure 18



Figure 19

29. Using the 1/8" allen key and a 7mm socket wrench, tighten the bolt stacks holding the sensor down.

30. Repeat steps 9-11 on the opposite side.

31. Install the provided mounting brackets (21887 (DS) and 21888 (PS)) behind the factory mounting location using the 21mm OEM bolts removed earlier. Do not fully tighten. (Figure 20 and 21)



Figure 20

32. With assistance, place bumper on brackets and install the bumper using the provided four (4) 7/16" hex head cap screws, eight (8) 7/16 flat washers, four (4) 7/16" lock washer, and four (4) 7/16" hex nuts. (50180-HW)

NOTE: Lower the tailgate to ensure there is no interference (including GMC step tailgate) with the bumper. If needed, loosen bumper and readjust.



Figure 21

33. Using a 5/8" open end wrench on the bolt head and an 11/16" Socket wrench on the nut, tighten bumper down.

34. Using a 21mm Socket wrench, tighten the bolts in the frame down. (Figure 22)



Figure 22

35. FOR SENSOR BUMPER INSTALLATION ONLY:

Test the sensors to ensure that the truck does not read the ground or any give off any errors.

36. Once the testing is complete, epoxy the sensor housings into place.

NOTE: Do not epoxy the sensors, only the housings.